

Coated components

Greater performance and reliability



Coated components

Greater performance and reliability

Published by
OC Oerlikon Balzers AG
Oerlikon Balzers Headquarters
Iramali 18
P.O.box 1000
LI-9496 Balzers
Liechtenstein

Tel +41 81 784 7500
E-Mail: info.balzers@oerlikon.com
www.oerlikon.com/balzers

© 2010
3rd edition/November 2010

Copying, translation into other
languages, microfilming, electronic
processing and all other forms of
reproduction and transmission are
forbidden without written permission
from the publisher.

Contents

It all comes down to the surface	07
Tribology under the magnifying glass	09
The tribological system	09
Friction	10
Typical wear mechanisms	11
Failings of simple material solutions	12
Advantages of surface treatment	12
Comprehensive surface technology	13
Surface treatment processes	13
PVD and PACVD processes	16
Hard coatings: classification and nomenclature	19
Properties of BALINIT® coatings	20
BALINIT® coatings at a glance	21
Advantages of BALINIT® coatings	28
Limitations of BALINIT® coatings	29
Coating as a design element	31
Choosing the right materials	31
Materials and their coatability	32
Hardness and strength of materials	34
Component surface quality	34
Component design for coating	35
Conservation and packaging	36
Application tailored solutions	37
Engine technology	37
Engines	37
Motor sport	41
Fuel injection	43
Mechanical drives	45
Vehicle gears	45
Industrial drives	49
Ball- and roller-bearings	51
Fluid technology	55
Compressors	55
Hydraulic pumps and hydraulic motors	57
Valves and fittings	60
Other applications	61

Partners in your success

65

Research and development	65
Test methods for quality assurance	66
Test methods for specification and analysis	68
Applications support	71
Custom services	71
Production process and process engineering	73
Quality management	74

Glossary

75

Tribology, PVD technology and coatings	
--	--

It all comes down to the surface

Friction is a key factor in the performance and service life of precision components. Frictional behaviour is chiefly governed by the properties of the component surface, therefore great importance is attached to methods of treating surfaces to improve their wear and corrosion resistance and thus reduce friction.

Oerlikon Balzers (hereinafter: Balzers) plasma-assisted coating processes have proved themselves excellent for creating economical, reliable tribosystems. Collaboration with our customers has taken us far beyond just coating: Today's customer also looks for competent help and support in the early development and design phases as well as professional project management, quality management, logistics and processes to meet the needs of mass production.

BALINIT® coatings offer reproducible quality in every run by virtue of the PVD and PACVD processes that Balzers has developed, together with technical quality systems that enable the manufacturer to meet and maintain specifications in the production process.

Experience has shown that many tribosystems can be optimised through the choice of the right coating. BALINIT® standard coatings cover a range of properties and make it possible to pick the coating that will yield the desired results. What is more, Balzers works with the customer to devise custom solutions for getting specific outcomes, thus allowing scope for creativity in design.

Coating enhances component performance, reliability and service life and permits lighter, more compact designs. Reduced energy consumption and the use of environmentally benign products in smaller quantities are further advantages that come into play in the building of machines and equipment just as they can in engine and vehicle making.

Components of machine tools, textile machines, injection moulding equipment for plastics, and equipment for food processing now come with BALINIT® coatings as a standard feature. Coating is also a proven technique in fluid technology, used to upgrade critical components in hydraulic drives, pumps and valves.

BALINIT® coating lends itself to mass production of engine components and enhances the performance of the whole system. Examples include BALINIT®-coated components in state-of-the-art diesel injection systems as well as wrist pins, tappets and piston rings. As a partner to renowned automakers and suppliers, Balzers is totally committed to developing innovative technologies.

This booklet will provide designers and their customers, as well as operating and maintenance engineers, with an overview of the processes used to make wear-resistant, low-friction surfaces with improved corrosion resistance. It will show off, in particular, the capabilities and advantages of BALINIT® PVD and PACVD coatings.

Tribology under the magnifying glass

Solving any wear problem begins with a careful analysis of the tribological system and all the factors that affect it. Such an analysis reveals what frictional states and wear mechanisms occur and when. Engineered processes for treating component surfaces, coating in particular, often result in more efficient solutions than pure material or design alternatives.

The tribological system

A tribological system consists of component surfaces that are in moving contact and thus become tribologically active. Friction and the resulting wear depend heavily on the composition and structure of the materials in the system. A further effect is often due to lubricants such as oil, grease or water. Particles on the surfaces also affect wear. Other factors at work include the prevailing service temperatures, the loads applied, and loading modes such as sliding, rolling, oscillating and pulsating. All these effects govern the

tribological system and its behaviour, and thus the extent, nature and progress of wear. The fundamental connection is thus between friction and wear.

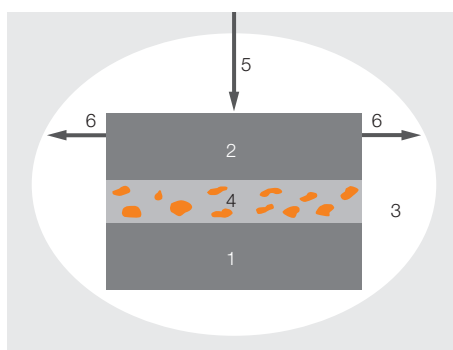

Tribosystem

- 1 Base object
- 2 Opposed body
- 3 Surrounding influences:
 - Temperature
 - Relative humidity
 - Pressure
- 4 Intermediate material:
 - Oil
 - Grease
 - Water
 - Particles
 - Contaminants
- 5 Load
- 6 Motion

Friction

Friction in a tribosystem can be classified by the state of the contact between interacting surfaces:

Dry friction occurs when the interacting surfaces are in direct contact.

Boundary friction is an intermediate state between dry and mixed lubrication, in which adsorbed lubricant molecules cover the interacting surfaces.

Mixed friction is a superposition of frictional states such as dry, boundary and fluid. Here the load is taken up partly by solid-to-solid contact and partly by a load-bearing lubricant film.

Fluid friction is friction in a liquid lubricant film that completely separates one contact partner from the other (hydrodynamic and hydrostatic friction).

All these frictional states obey the rule that friction (and thus the danger of wear) increases with increasing direct contact between the two relatively moving partners. The degree of friction in a tribosystem is described by the

coefficient of friction μ , which depends on the frictional state and the tribological factors that are at work in an application process.

The **Stribeck curve** shows that the coefficient of friction is especially low for fluid friction in oil-lubricated tribosystems. This state, however, depends

on constant service conditions and appropriate system design. Mixed and boundary friction often cannot be completely avoided, despite lubrication, and this is especially true when a triboprocess is being started up or allowed to run down. A wide variety of wear mechanisms can occur as a result.

Stribeck curve: schematic graph of friction

Coefficient of friction μ

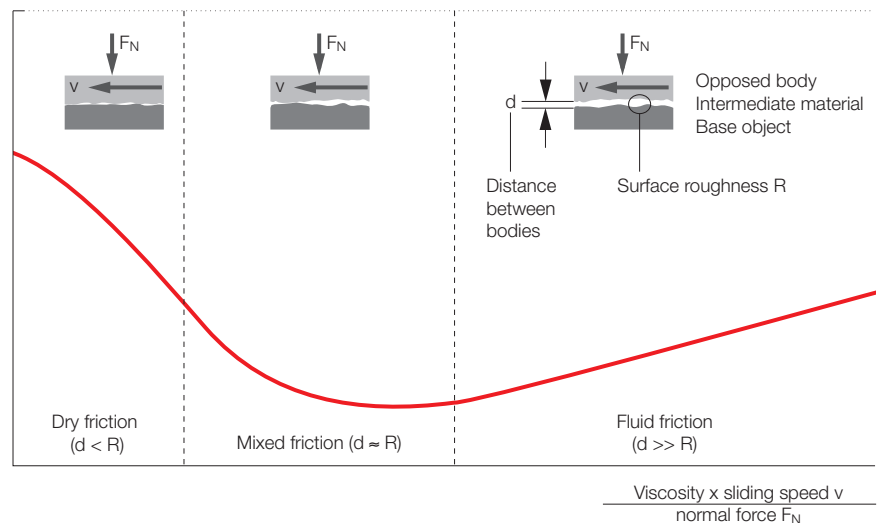

Stribeck curve: oil lubrication and friction coefficient

The Stribeck curve describes how the coefficient of friction varies in oil-lubricated tribosystems. Low values are seen above all in fluid friction, that is, when the sum of the roughness (asperity) heights of the frictional partners is less than the thickness of the lubricant film. This condition can come about only if the parameters viscosity/sliding speed/load (normal force) are in the

proper proportion. What is more, the design of the tribosystem must permit the formation of a gap that narrows in the direction of flow, because the lubricant film must be able to exert a pressure against an externally applied force. Mixed, boundary or dry friction can occur if the thickness of the lubricant film becomes smaller as the sliding speed decreases or the load increases.

Typical wear mechanisms

It seldom happens in practice that a wear mechanism occurs alone in a tribosystem. As a rule, several of these mechanisms act together or in succession during the wear process. Failure due to wear, however, commonly results from one mechanism playing a dominant role.

Abrasive wear comes about when material is torn away by hard or sharp-edged particles in between the interacting surfaces, but can also result from hard or sharp-edged (abrasive) surfaces and asperity peaks of one or the other partner. Abrasion is promoted when the surfaces have very differ-

ent hardnesses or when the harder surface is sufficiently rough or sharp-edged.

Consequences include scratches, grooves, chips and material removal at the surfaces.



Adhesive wear occurs when two tribologically active surfaces in a state of mixed or dry friction form an intimate, adhesive bond. This can be the case if the surfaces have the same composition or show a strong tendency to combine and there is no protective passive film.

Consequences include cold welding with material transfer, pits, smearing or similar damage to the surface structures (scuffing, scoring, galling).

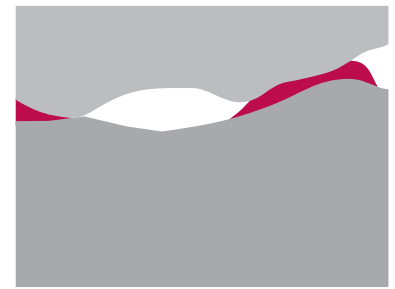

Surface fatigue results from repetitive (pulsating or alternating) mechanical or hydraulic loads that lead to crack formation and propagation below the loaded surface, culminating in damage to the surface. If the surface is loaded by friction, wear can be reduced by diminishing the friction coefficient. In

terms of hydraulic loads, the hardness and elasticity of the material are crucial.

Consequences of surface fatigue include cracking, pitting and micropitting, especially where elements are in rolling contact. On hydraulic components cavitation-erosion occurs.



Tribo-oxidation involves a chemical reaction induced by the tribological (frictional) contact and yielding products that have a detrimental effect on the tribological processes at the surfaces. For example, a closely tolerated pair of components or the seat of a rolling bearing may seize up.

Tribo-oxidation can be controlled by lowering the temperature and the coefficient of friction, providing inert (unreactive) contact surfaces or designing surfaces with better form stability.

Consequences include fretting corrosion.

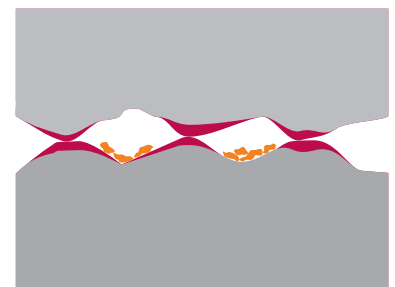

Failings of simple material solutions

The identification of wear mechanisms in tribosystems gives the first pointer to how wear might be combatted:

- Reducing the friction coefficient
- Increasing the surface hardness
- Applying inert surface coatings

If the sole approach tried in order to reduce wear is selection of the materials of construction, it turns out that

some materials offer tribological advantages such as high strength but have drawbacks such as susceptibility to corrosion at the same time. Other constraints on material selection arise from requirements on design, weight, function, cost, availability, and environmental considerations.

Greater scope for design is opened up especially with surface coatings applied by **PVD** (physical vapour deposition) or **PACVD** (plasma-assisted chemical vapour deposition). The base material provides strength and toughness, while the coating guards against wear and corrosion and reduces friction. The main coating materials used are carbon-based, but nitride coatings have also proved useful for many applications.

Advantages of surface treatment

The treatment of component surfaces, on the other hand, offers a better outlook for success. For one thing, it may be possible to produce the desired tribological behaviour in the system without a costly change of design or materials. For another, surface treatments open up room for design improvements while the component is still under development. Surface properties can be manipulated in order to realise certain advantages in the technological competition:

- Longer service life
- Ability to tolerate greater loads
- Ease and low cost of maintenance
- Environmental gains and conservation of resources
- Improved response in kinetic systems
- Lower energy consumption
- Resistance to corrosion
- Possibility of designing to close tolerances
- Use of lower-cost base materials

Comprehensive surface technology

A comparison of engineered surface treatment methods for precision components reveals that PVD and PACVD coating processes enjoy many advantages: Not only do they make it possible to apply wear-resistant, low-friction hard coatings in a precise, environmentally safe way that is tailored to the application in question, but they can also be modified to reach target figures such as hardness, friction coefficient and thickness. Balzers groups these hard coatings under the BALINIT® brand.

Surface treatment processes

DIN (German Institution for Standards) guideline 8580 identifies two classes of manufacturing processes by which the tribological processes that take place at material surfaces can be influenced:

- **Application of coatings** by such processes as electrodeposition, thermal sputtering or deposition from the gas or vapour state (PVD/PACVD)
- **Modification of material properties** by means of nitriding or boronising, for example.

All these processes have special applications associated with their distinctive properties. In many cases, however, a variety of processes can be employed, particularly when stresses are not too great.

Electroplating processes

The most important electrochemical and chemical processes for protection against wear and corrosion are hard chrome-plating and chemical nickel-plating.

Hard chrome (approx. 1,200 HV) is applied in coating thicknesses of up to 200 µm. It is suitable for components subject to abrasive wear, but micro-cracking inherent in the process limits its use against corrosion. While micro-cracks can be avoided by application of a thin coating (a few µm thick with a hardness of 1,200 HV), such a coating offers only limited wear resistance.

Chemical nickel can be applied over a range of hardnesses, depending on the process conditions; the maximum is approx. 600 HV. The advantage of chemical nickel coatings lies chiefly in corrosion protection. The tribological properties can be enhanced by inclusions (dispersion) of hard (diamond, silicon carbide) or soft (PTFE) phases.

The **nitriding process** involves diffusing nitrogen into the steel surface to harden the metal in the boundary zones down to a typical depth of 0.5 mm. A hardness of approx. 900 HV is attained in the outer diffusion zone. A compound layer (iron nitride such as Fe₄N) up to 20 µm thick can be formed, depending on the process conditions and the substrate material. These nitride zones are resistant to moderate wear and corrosion.

Many electroplating and nitriding processes involve environmentally problematic media. In addition, classical hard chrome-plating baths contain hexa-valent chromium compounds, which are carcinogenic. The construction of some kinds of electrochemical plants is no longer feasible in many industrial regions; the same is true of salt-bath nitriding plants.

Key properties of **PVD** and **PACVD** processes include:

- **A wide range of coatings** can be made. The high vacuum employed makes it possible to achieve coating properties that are not available with gases and baths at atmospheric pressure (thermal spraying, nitriding, electro- or chemical deposition). The resulting coatings offer good adhesion, high hardness and wear resistance, and these properties are often specially tailored for the service in question.

- PVD/PACVD processes as used for component coating operate at relatively **low coating temperatures** of 200-500 °C. These temperatures are chosen to lie at or below the tempering temperature of steels in order to avoid altering the fundamental material properties.

- **Coatings are thin**, typically 0.5-4 µm. This feature in conjunction with close tolerancing means that the component retains its form, fit and dimensions after coating without the need for costly refinishing.

- PVD/PACVD processes are **environmentally benign** and do not entail the use or emission of pollutants. The gases used are noble gases such as argon together with ordinary working gases such as hydrogen and acetylene. No toxic reaction products are generated.

Coating thicknesses and process temperatures

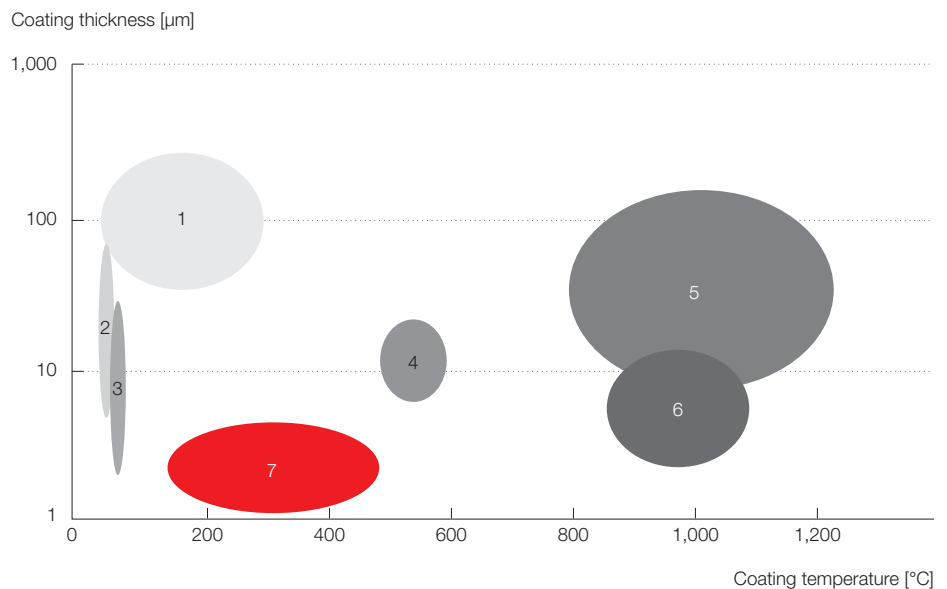

- 1 Plasma spraying
- 2 Electrolytic and chemical deposition
- 3 Phosphating
- 4 Nitriding (white layer)
- 5 Boronising
- 6 CVD
- 7 PVD, PACVD

Applications of surface treatment processes

	Protection against Scuffing	Protection against Abrasion	Protection against Corrosion	Application areas
Electroplated hard chrome	+	++	+	Chemical apparatus, food industry, hydraulics
Electroless nickel plating	+	+	+++	Chemical apparatus, food industry, hydraulics
Diffusion processes (nitriding, nitrocarburisation, boronising)	+	++	+	Engine components, tools
Plasma spraying	+	++	++	Turbine vanes
CVD (thermal)	++	++	+	Tools
PVD hard coatings (TiN, TiCN, TiAlN, CrN)	++	++	+	Tools, machinery, engine components, motor sport
PVD/PACVD carbon coatings (WC/C, DLC)	+++	++	++	Machinery, engine components, motor sports

Tribological advantages: PVD and PACVD coatings

Coatings applied by PVD and PACVD offer far superior tribological performance:

- PVD and PACVD coatings, particularly carbon coatings, feature a unique combination of protection against scuffing and abrasion.
- The dry-running qualities of treated and untreated components illustrate, above all, what protection against scuffing and surface fatigue results from surface coatings. Data from

sliding-wear tests show that, after a running-in phase, BALINIT® carbon-based coatings have low coefficients of friction, which have a positive effect especially under conditions of deficient (starved) lubrication and mixed friction.

- PVD hard coatings have only a slight chemical-physical interaction with metals. For this reason, they are also well-suited to preventing tribo-oxidation. The properties of PVD coatings also improve corrosion protection and thus guard components from external factors.

Sliding-wear test

Experimental method:

- 1 Ball, nonrotating, diam. 3 mm
AISI 52100 (DIN 1.3505), 60 HRC
- 2 Test ring: AISI 52100 (DIN 1.3505), 60 HRC
Abrasive-blasted or polished, N4
Coated

Test conditions:

- F = 30 N
- v = 0.3 m/s
- Dry contact

Dry-running/Sliding-wear test

Coefficient of friction

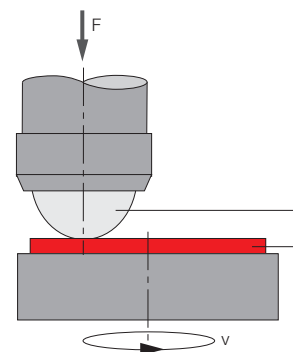
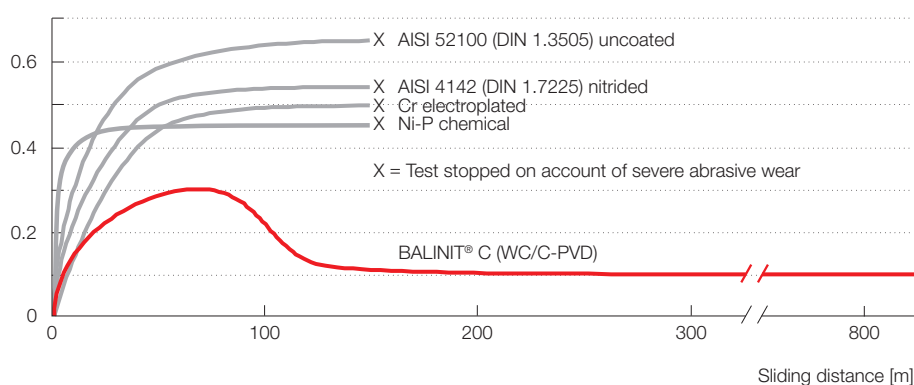



PVD and PACVD processes

The advantages set forth on the previous pages explain why Balzers has focussed on PVD (physical vapour deposition) and PACVD (plasma-assisted chemical vapour deposition) for the coating of precision components. The technologies used are ones that work with plasma assisted processes and can be both flexibly and precisely controlled: **sputtering, ion plating, arc evaporation and PACVD.**

Sputtering

In reactive sputtering (cathodic sputtering), cleaned and pretreated components for coating are placed on a turntable and loaded into the vacuum chamber of a PVD sputtering machine. After the components have been heated, they are bombarded with argon ions (ion etching) to produce a clean metal surface free of atomic contaminants – a key requirement for coating adhesion. Next, a high negative electric potential is applied to the sputtering sources, which contain the coating material. A gas discharge is struck, leading to the formation of positive argon ions, which are accelerated toward the coating material and evaporate it. A reactive gas containing the nonmetallic

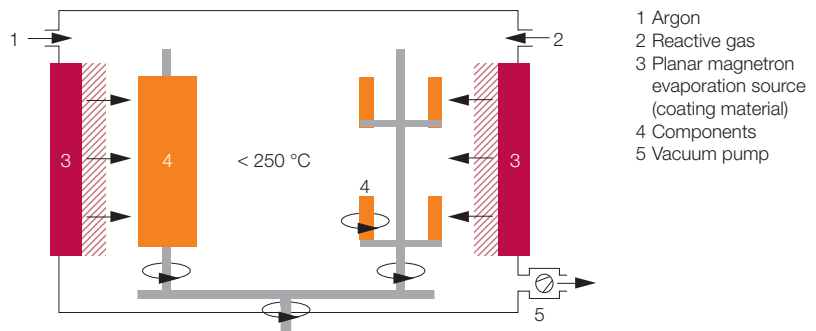

elements of the coating is admitted to the chamber, and the sputtered particles react with it. A thin, compact hard coating with the desired structure and composition is thus formed on the components. In order to maintain a consistent coating thickness, the components are rotated about one or several axes at constant speed during the coating process.

Balzers uses sputtering only to apply the **WC/C coating**. The coating material contains tungsten, while the reactive gas contains carbon. The coating system that results is made up of a carbon and hydrogen matrix with inclusions containing tungsten. This WC/C coating (a-C:H:W) is marketed as **BALINIT® C**.

Enhanced sputtering

The **BALINIT® CNI chromium nitride coating** is applied by an enhanced sputtering process, which works on a similar principle. The coating material contains chromium, nitrogen gas is present, and there is an additional ionisation step. A low-voltage arc discharge in the middle of the machine enhances the plasma intensity several-fold and thus produces a much higher degree of ionisation.

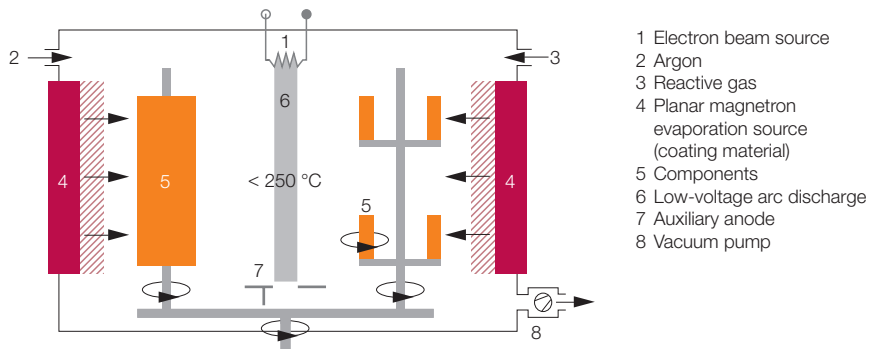

Ion plating

Ion plating is a PVD process involving reactive electron-beam evaporation. In ordinary sputtering, a metal plate is bombarded with argon atoms to generate the coating material. The metallic component for ion plating (e.g., titanium or chromium) is evaporated by a low-voltage arc. Balzers employs ion plating to apply, among others, the **BALINIT® A titanium nitride coating**.

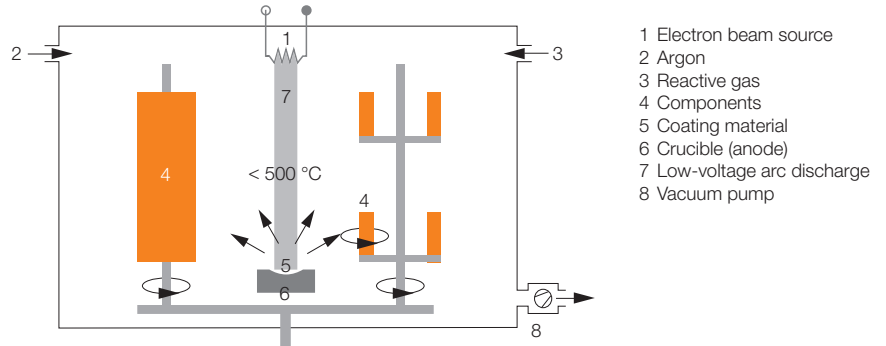

- 1 Electron beam source
- 2 Argon
- 3 Reactive gas
- 4 Components
- 5 Coating material
- 6 Crucible (anode)
- 7 Low-voltage arc discharge
- 8 Vacuum pump

Arc Evaporation

In arc evaporation, an arc is struck between the backing plate (anode) and the coating material (cathode). The arc moves over the coating material and evaporates it. Because of the high currents and power densities employed, the evaporated material is ionised to a high degree. Reactive gas and metal ions hit the component surface and are deposited there as the coating material. Balzers uses this process to make, among others, the **BALINIT® FUTURA NANO titanium-aluminium nitride coating**.

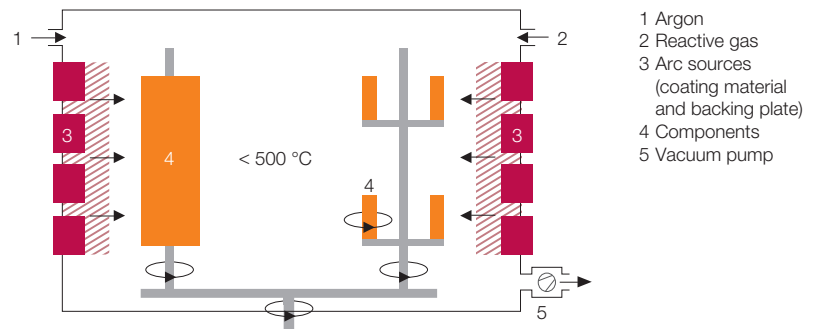

- 1 Argon
- 2 Reactive gas
- 3 Arc sources (coating material and backing plate)
- 4 Components
- 5 Vacuum pump

PACVD process

The high-frequency PACVD process comes into play when Balzers applies the **BALINIT® DLC metal-free carbon coating**. The setup is similar to that used for sputtering, but a high-frequency AC voltage is imposed after a metallic adhesion film has been sputtered. A gas discharge, initiated in the vacuum chamber after the reaction gas is injected, generates carbon and hydrogen atoms (ions and radicals), which form a compact coating on the components. The coating properties can be controlled by changing the applied voltage.

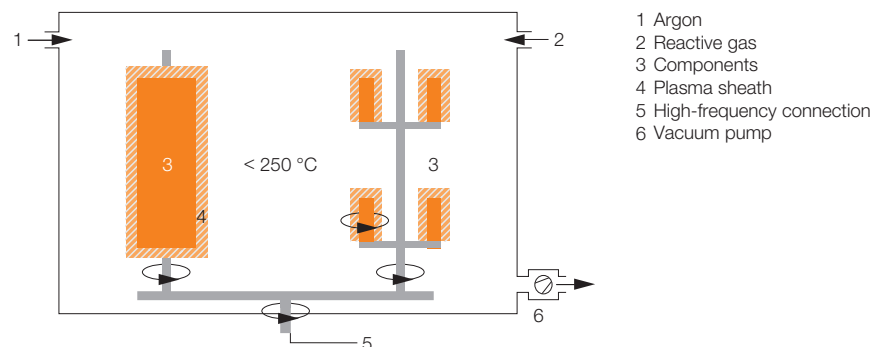

- 1 Argon
- 2 Reactive gas
- 3 Components
- 4 Plasma sheath
- 5 High-frequency connection
- 6 Vacuum pump

Combined PVD/PACVD process

The enhanced sputtering process is combined with PACVD in order to apply **carbon-containing multifunctional coatings** such as BALINIT® DLC STAR. A hard, tough metal layer is deposited by sputtering, and PACVD is used to build up the tribologically effective carbon coating on top of it. In contrast to conventional combination coatings, Balzers multifunctional coatings are made in a single process that yields homogeneous, defect-free coatings of uniquely high quality and adhesion strength.

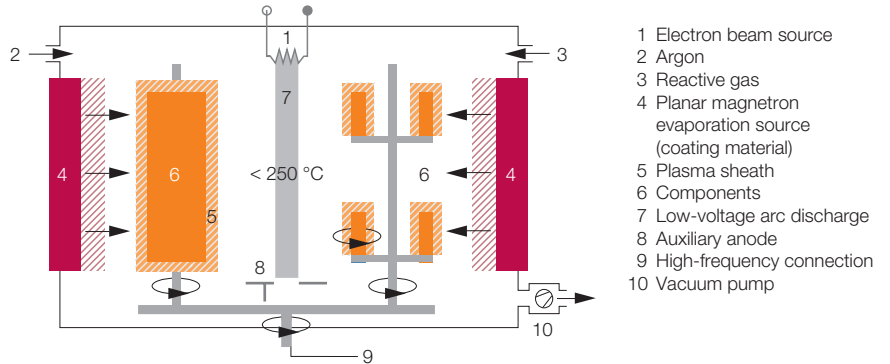

- 1 Electron beam source
- 2 Argon
- 3 Reactive gas
- 4 Planar magnetron evaporation source (coating material)
- 5 Plasma sheath
- 6 Components
- 7 Low-voltage arc discharge
- 8 Auxiliary anode
- 9 High-frequency connection
- 10 Vacuum pump

P3e™ Pulse Enhanced Electron Emission

With the P3e™ coating technology, Balzers became the world's first company to deposit **hard corundum typed aluminium-oxide based coatings** in a PVD process at temperatures significantly below 600 °C. Such coatings formerly could be produced only by CVD at much higher temperatures. For certain qualities of cemented carbides, however, the CVD process poses the danger of embrittlement, and it was nearly impossible to coat steels at all. PVD oxide coatings were developed primarily for tools, but they are also suitable for mechanical elements where insulating properties are desired along with resistance to high temperatures and corrosion.

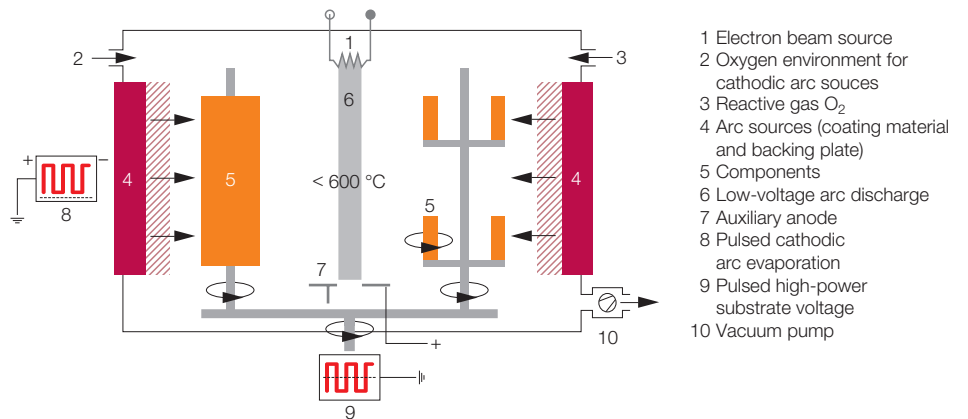

- 1 Electron beam source
- 2 Oxygen environment for cathodic arc sources
- 3 Reactive gas O₂
- 4 Arc sources (coating material and backing plate)
- 5 Components
- 6 Low-voltage arc discharge
- 7 Auxiliary anode
- 8 Pulsed cathodic arc evaporation
- 9 Pulsed high-power substrate voltage
- 10 Vacuum pump

Hard coatings: classification and nomenclature

Quite a large number of coatings can be made by the PVD and PACVD processes that have been described. Their classification and nomenclature begins with a separation of the most important hard coatings into three groups. The first includes coatings in which metals and nitrogen combine to form metal nitrides (TiN, CrN, TiAlN, etc.). The second group comprises carbide coatings generated from metals and carbon (TiC, WC, NbC, etc.). There are also blends of materials from these two groups (such as TiCN). Carbon coatings containing metals (a-C:H:Me) and those free of metals (a-C:H) make up the third group.

In nitride hard coatings, metal atoms from groups IV-VI of the periodic system (Ti, Cr) form compounds with non-metal atoms (C, N, O). Stoichiometric compounds (i.e., 50% metal atoms and 50% nonmetal) are commonly chosen because such compounds frequently offer the most favourable properties.

Carbon coatings are most often formed through the use of hydrocarbons. The kind of amorphous hydrocarbon network (a-C:H) produced will vary with the process conditions. The carbon atoms can have graphitic (sp^2) or diamond-like (sp^3) bonds; the coefficient of friction as well as the hardness of the coating depend on the ratio of the bonding type. As a consequence, an inconsistent blend of material, pro-

cess and group nomenclature is encountered in the market. The English abbreviation "DLC" (diamond-like carbon), for example, refers to the whole group of amorphous carbon coatings, but DLC is inadequate as a term for any individual carbon coating belonging to this group.

The Balzers product family of carbon coatings has its own brand names, with BALINIT® C denoting the a-C:H:Me system (WC/C) and BALINIT® DLC the a-C:H coating.

Hydrogen-free carbon coatings make up a further class. These are identified as tetragonal carbon or amorphous diamond (ta-C).

Nomenclature of carbon coatings

	Scientific name	Balzers brands	Other names found in the market
Metal-free carbon coatings	a-C:H	BALINIT® DLC	DLC (diamond-like carbon) iC (ionic carbon) a-DLC
Metal-containing carbon coatings	a-C:H:Me Me = metal (e.g. tungsten, titanium, tantalum)	BALINIT® C	DLC (diamond-like carbon) Me-DLC MeC (metal-carbon) iC/Me Me-C:H MeC/C MCH
Hydrogen-free carbon coatings	ta-C		Amorphous carbon Amorphous diamond

Coating materials and material structure

Nitride coatings

Metal: Ti, Cr, Al
Nonmetal: C, N, B

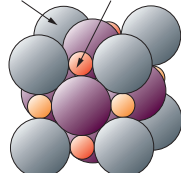

Carbon coatings

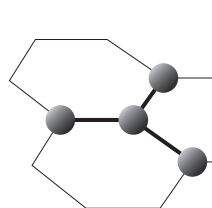

Graphite (sp^2)

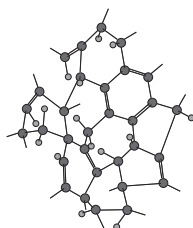

DLC (sp^2 and sp^3)

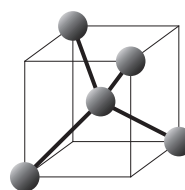

Diamond (sp^3)

Properties of BALINIT® coatings

BALINIT® PVD and PACVD coatings have qualities that make them superbly well-suited to use on precision components:

- High hardness
- Good wear resistance
- Low coefficient of friction
- Good corrosion resistance
- Thin coatings
- High precision, excellent replication of contours
- Good adhesion

The **coating thicknesses** generally range from 0.5 to 5 µm, whereby the coatings exactly match the surface topography of the component and so remain faithful to its shape. Edge sharpness and surface roughness remain virtually unchanged. This means that remachining is no longer needed; the coating can become the last step in component manufacturing.

Coating adhesion: Ion etching before the start of material deposition results in excellent metallurgical bonding of the coating to the substrate material. In spite of their great hardness, BALINIT® coatings adhere so well that flaking does not occur even when the surface undergoes plastic deformation.

Properties and tribological effectiveness of BALINIT® coatings

	BALINIT® C	BALINIT® C STAR
Coating material	a-C:H:W (WC/C)	CrN + a-C:H:W
Typical microhardness (HK 0.01)*/***	1,000 1,500	1,000 1,500
Typical coating thickness (µm)	1 - 4	3 - 5
Increase in surface roughness R_a (µm)*	approx. 0.02	approx. 0.02
Coefficient of friction against steel (dry)*	0.1 - 0.2	0.1 - 0.2
Coating temperature (°C)	< 250	< 250
Maximum service temperature (°C)*	300	300
Coating colour	anthracite	anthracite
Protection against abrasive wear	+ ++	+ ++
Protection against adhesive wear	+++	+++
Protection against tribo-oxidation	++	++
Protection against surface fatigue	+++	++
Protection against corrosion*	+	+

* Depends on application and test conditions

** Ion plating

*** HK (Knoop hardness) corresponds approximately to HV (Vickers hardness)

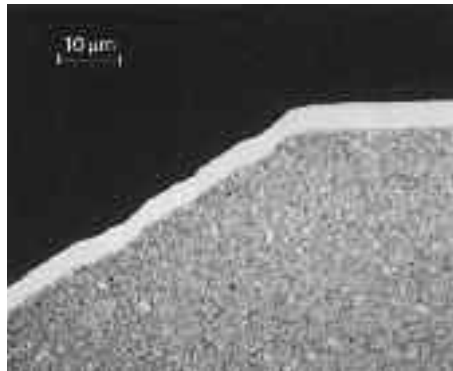

Excellent replication of contours with BALINIT® coatings

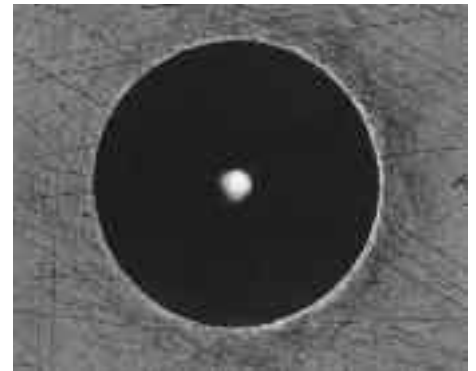

Excellent adhesion of BALINIT® coatings

BALINIT® DLC	BALINIT® DLC STAR	BALINIT® CNI	BALINIT® D	BALINIT® A	BALINIT® FUTURA NANO
a-C:H	CrN + a-C:H	CrN	CrN	TiN	TiAlN
> 2,000	> 2,000	1,750	1,750	2,300	3,300
0.5 - 3	2 - 4	1 - 4	1 - 4	1 - 4	1 - 4
approx. 0.02	approx. 0.02	approx. 0.02	approx. 0.2	approx. 0.03** / approx. 0.2	approx. 0.2
0.1 - 0.2	0.1 - 0.2	0.5	0.5	0.4	0.4
< 250	< 250	< 250	< 500 / < 250	< 500 / < 250	< 500 / < 250
350	350	700	700	600	900
black	black	silver-grey	silver-grey	gold-yellow	violet-grey
+++	+++	++	++	++	+++
+++	+++	++	++	++	++
++	++	++	++	++	++
++	++	++	++	++	++
++	++	++	++	++	++

BALINIT® coatings at a glance

BALINIT® C BALINIT® C Star

Properties

BALINIT® C is a metal-containing amorphous carbon coating (a-C:H:W or WC/C) with a multilamellar structure. Phases rich in tungsten carbide and carbon alternate every few atomic layers, giving a very low coefficient of friction at dry running: 0.1 to 0.2. In BALINIT® C STAR, the combination of a metallic support layer (CrN) with the tribologically effective carbon coating enhances the load-bearing capacity.

Benefits

BALINIT® C is highly resistant to adhesive wear (scuffing) in particular. It has a high load-bearing capacity even under conditions of deficient lubrication or dry contact. Thanks to its low friction coefficient, it also acts to reduce surface fatigue (pitting) and tribo-oxidation (fretting corrosion). The 1,000

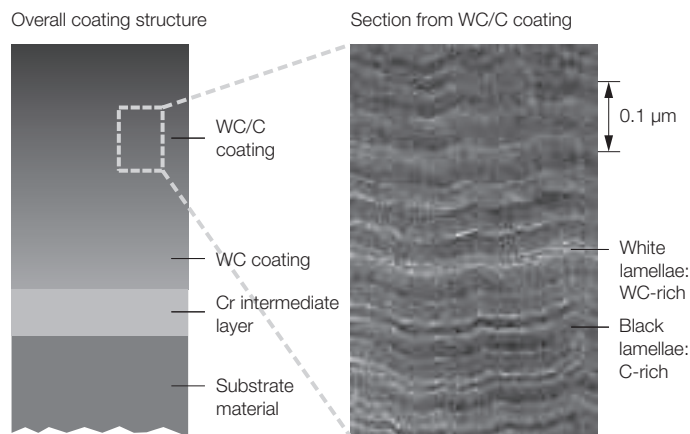

Coating structure of BALINIT® C

The multilamellar structure of the BALINIT® C coating results in good running-in and burnishing behaviour and reduces dry friction.

HK grade of BALINIT® C is used where abrasive conditions are milder and surface pressures are high but sliding speeds are relatively low. This BALINIT® C grade shows excellent running-in and burnishing behaviour under constant sliding load by virtue of its moderate hardness. The harder (1,500 HK) grade of BALINIT® C can be used where sliding speeds are higher; it offers better protection against abrasive wear. BALINIT® C STAR has been found to perform well under very high surface pressures on soft substrates.

Special frictional properties

Dry running

Dry running is the case most frequently studied – not because it is the most common application but because it is well-defined and easy to measure. This condition brings out the special qualities of the BALINIT® C (WC/C) coating: its very good burnishing behaviour during run-in and its slight coating transfer, with burnishing of the mating part as a side effect. In comparison with other friction-reducing materials such as MoS₂, graphite-based paints and Ni-PTFE coatings, WC/C combines low friction with high wear resistance.

BALINIT® C in dry running and starved lubrication (gear test)

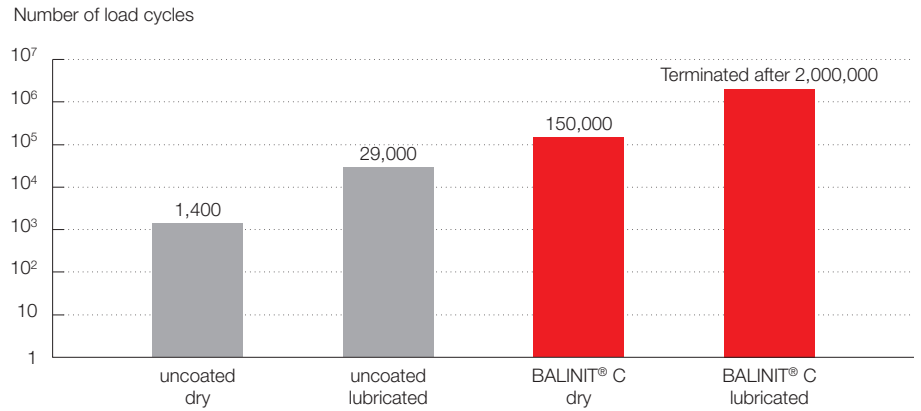

FZG test

Speed: 1,000 rpm
Surface pressure: 1,000 N/mm²

Lubricant: Esso CL46B (plant-based)
Lubricant feed rate: 1 drop per minute
Source: IMM (TU Dresden)

Burnishing and material transfer with BALINIT® C coating

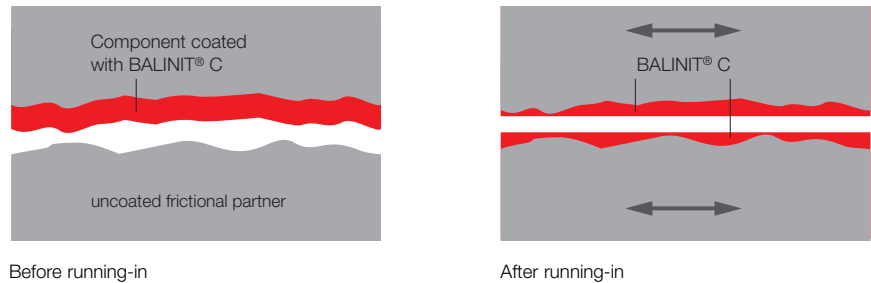

BALINIT® C: comparison of frictional performance

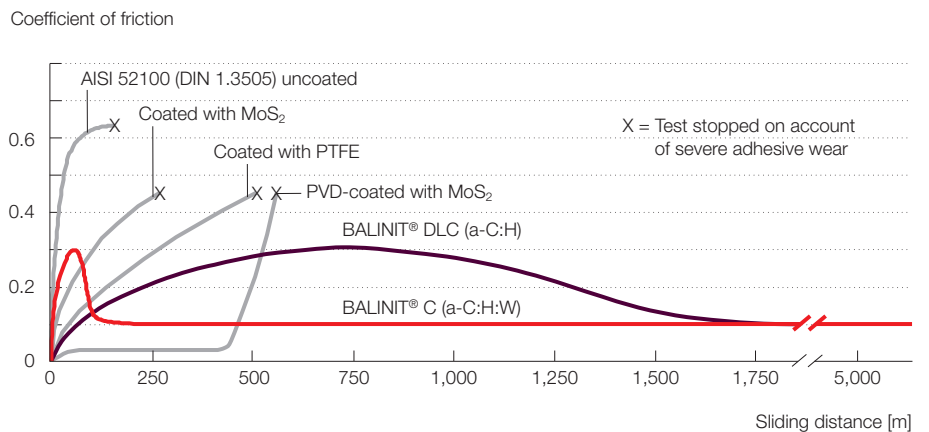

MoS₂ = Molybdenum disulfide

PTFE = Polytetrafluoroethylene (Teflon®)

Performance of BALINIT® coatings in mixed friction

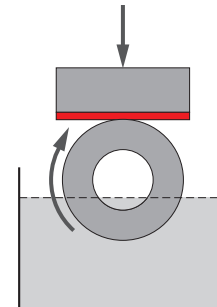
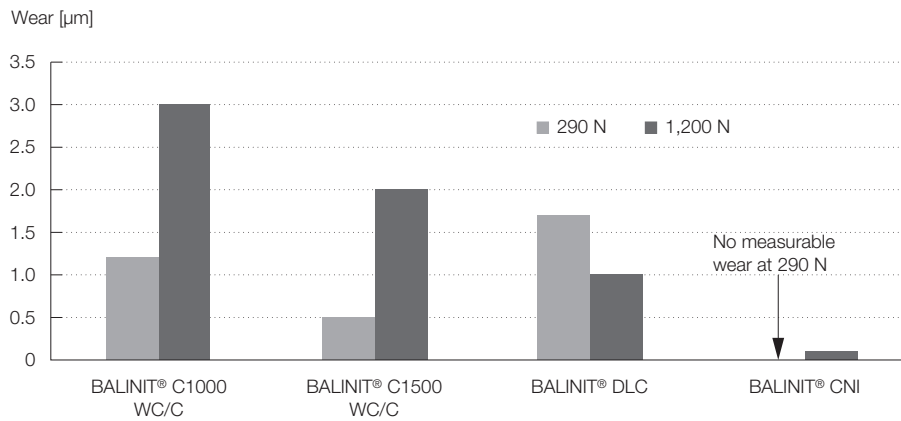

Block-ring test

Block coated
Speed: 0.3 m/s
Load: 290 N/1,200 N
Oil: 5W-30

Mixed friction

Carbon coatings are employed in lubricated systems far more often than in dry-running ones. The behaviour of coatings with, and in comparison to, lubricants has been demonstrated in a gear scuffing test (see page 22). Experiments performed by the IMM (Institute of Machine Elements and Machine Design) at the Technical University of Dresden show that both light lubrication and WC/C coating can lead to marked gains in service life, but the best results are obtained with a combination of the two. This means on the one hand that coating cannot supplant regular lubrication, but on the other hand that lubrication and WC/C coating act in a positive synergy.

Not only carbon but also nitride coatings come out well in mixed-friction tests. Chromium nitride in particular may actually surpass carbon coatings.

Coatings and additives

Additives are frequently employed to reduce wear in lubricated systems. Efforts to identify the action of additives when used with coated parts have been under way for some years. The effects have been found to be slight on the whole. The coating (WC/C is the one most studied) and the additive work together positively in many cases but negatively in many others. For example, sulphur-based high-pressure additives together with the tungsten in the WC/C coating form WS_2 compounds that reduce friction similarly to MoS_2 . This effect was measured at short running times, high pressures and low sliding speeds.

In most instances the coating has the more robust and permanent action. This is no surprise, for the coating is applied as a uniform, hard and wear-resistant film while additives take the form of small soft particles that come into play only under load.

Two trends lie in store for the future. Firstly, additive use will decline on environmental grounds, with coatings used instead. Secondly, additives are being developed and tested that can cooperate with PVD coatings to deliver greater performance than either practice alone.

Applications

BALINIT® C finds use in all domains of mechanical engineering, in motors and transmissions, and also in fluid technology. This coating also aids functional reliability in systems where lubricants must not be employed (cryogenic and vacuum systems, clean rooms, food equipment). BALINIT® C is particularly suitable for case-hardening as well as ball- and roller-bearing steels because it can be applied at temperatures under 200 °C.

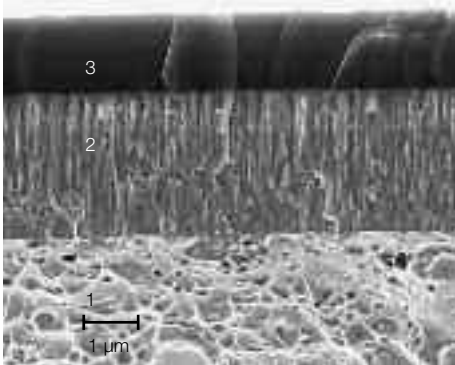

Typical structure of a multifunctional BALINIT® coating of the STAR series:
 1 Base material (component)
 2 CrN supporting layer
 3 Tribologically effective carbon layer

BALINIT® DLC BALINIT® DLC STAR

Properties

BALINIT® DLC is a pure, metal-free, amorphous carbon coating that contains only carbon and hydrogen. Its diamond (sp^3) bonding content is higher than in BALINIT® C coatings. The coating is therefore very hard and compact ($>2,000$ HK). It also features extreme chemical stability and a dry friction coefficient of 0.1 to 0.2. A special coating technology results in very good adhesion despite high internal stresses. For extreme load situations, the carbon coating can be combined with a metallic (CrN) support layer (BALINIT® DLC STAR).

Benefits

BALINIT® DLC is suitable for the most drastic wear conditions and high relative sliding speeds. The strengths of this coating lie in protection against abrasion, tribo-oxidation and adhesion (scuffing). The coating can accommodate surface pressures that would quickly lead to scuffing and cold welding under normal service conditions. Frictional losses are minimised and corrosion resistance is enhanced. BALINIT® DLC STAR improves the load-bearing capacity of hard DLC coatings.

Wear coefficient and friction

Where parts experience sliding wear, a combination of low friction and high abrasion resistance is crucial. Friction is measured in the pin-disc dry sliding-wear test. Abrasion resistance is determined in the calowear test, where a steel ball rotates on the surface and diamond paste is added so that the ball grinds a spherical pit in the coating. The lowest friction and wear rates, and thus the best conditions for sliding-wear applications, are achieved with BALINIT® DLC coatings.

Coefficient of friction and wear

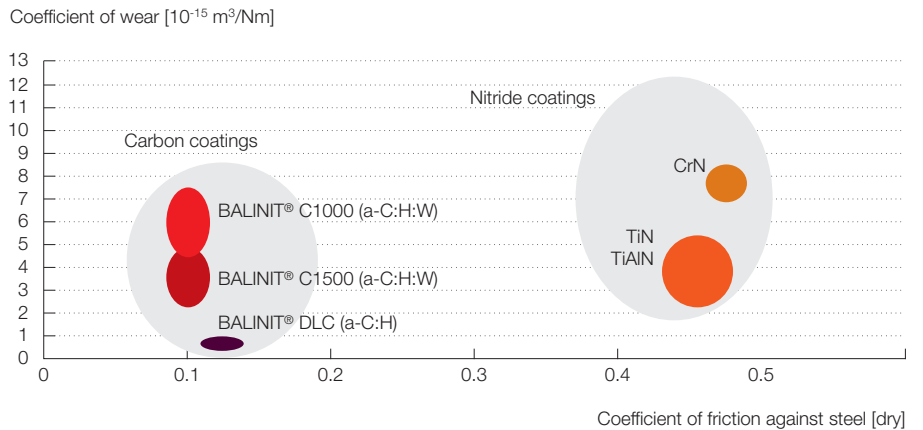

BALINIT® DLC STAR coating for valve seats

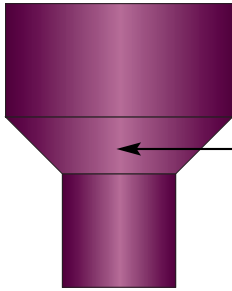

Needle seat (schematic)

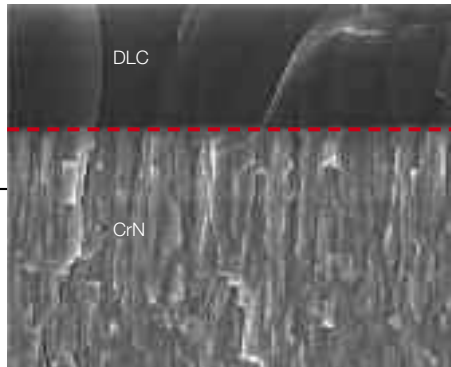

Fracture surface of BALINIT® DLC STAR coating

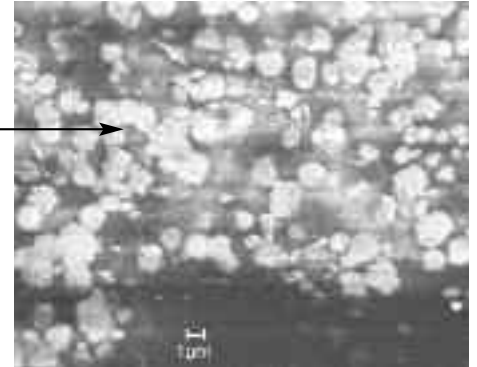

Top view on worn surface
Bright dots: tips of CrN grains
Dark background: run-in DLC coating

BALINIT® DLC STAR coating for valve seats

Sliding wear and abrasion are not the only loads on components such as the injector needles of diesel injection systems. High cyclical tensile-compressive loads combined with extremely fast micro-motions also act on the conical seal surfaces that work at high frequency to regulate fuel feed. These surfaces not only experience friction and abrasion but are also subject to severe surface fatigue. Both the hard

multifunctional carbon coating BALINIT® DLC STAR and nitride coatings have proven to perform well under such conditions. In the case of BALINIT® DLC STAR, the DLC coating ensures good running-in behaviour while wear is generally blocked at the CrN-DLC interface. Scanning electron micrographs show this clearly: The white spots indicate the tips of columnar CrN crystals and the surrounding dark areas represent the run-in DLC coating.

Applications

BALINIT® DLC coatings are used in motor sports, in the automotive and textile industries, instrumentation, pumps, seals, valves and other precision components where good wear resistance and high surface quality are needed. The virtues of this coating also come into play in severely stressed components of modern diesel fuel-injection systems. BALINIT® DLC STAR decisively improves the performance and durability of valve-train components, wrist pins and high-pressure pump components.

BALINIT® CNI

Properties

BALINIT® CNI is a chromium nitride (CrN) coating applied by a special process that yields a particularly dense, smooth coating. The increase in roughness R_a is less than $0.02 \mu\text{m}$, inside normal manufacturing tolerances, and the coating hardness of 1,750 HK is substantially greater than that of electroplated hard chrome (approx. 1,000 HK).

Benefits

Components coated with BALINIT® CNI display good wear resistance and good frictional qualities under conditions of deficient lubrication when they are subject to severe mechanical loads. At the same time, they show improved corrosion resistance. Because the coating temperature is less than 250°C , a broad range of materials can be coated. The coatings are faithful to the component shape and can thus be applied as the final step in the manufacturing process; no further machining is needed. What is more, the production process does not generate pollutants or residues.

Applications

The application spectrum of BALINIT® CNI extends from wear protection in machinery and hydraulics (pistons) to the automotive (valve train components, piston rings) and the aircraft industry. As BALINIT® coatings are FDA (Food and Drug Administration) approved, BALINIT® CNI can be applied to parts that come into direct contact with foods. Other applications arise wherever thin electroplated chrome and nickel have been used in the past. By virtue of its special process, BALINIT® CNI has also proved a highly conductive material and exhibits excellent chemical stability at electrical junctions. Chemical electrodes, hot contacts and fuel-cell applications are applications in which BALINIT® CNI provides good electrical conductivity even in the most drastic environments.

A key property of PVD coatings is their thinness, which sets them apart from conventional electroplated and thermal spray coatings. The gaps between these processes, however, are increasingly being closed with thinner electroplated as well as thicker PVD coatings. CrN coatings up to $50 \mu\text{m}$ thick are now being applied to relatively precise parts subject to heightened abrasive or corrosive wear. Typical examples are coatings for piston rings, pumps for abrasive media and components of textile machinery (thread guides and components in contact with fibres).

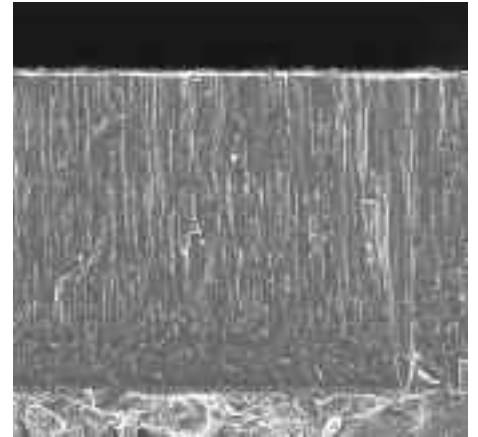

Coating structure of BALINIT® CNI

This chromium nitride coating offers not just great hardness but also a high degree of tightness and smoothness. Coated components show improved wear and corrosion resistance as well.

Corrosion test

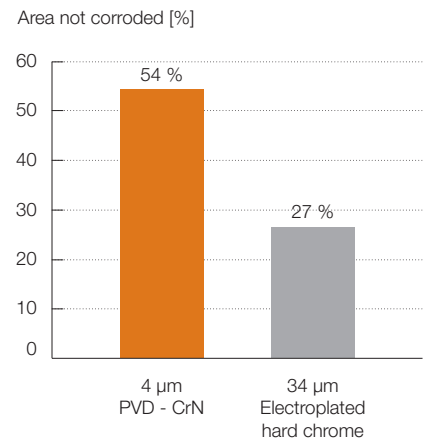

Comparison of CrN applied by PVD with electroplated hard chrome in the 48 hr salt-spray test of DIN 50021 SS.
Specimen: Untreated ball-bearing steel AISI 52100 (DIN 1.3505)
Surface quality: N2 / $R_a = 0.04$ / $R_z = 0.4$

BALINIT® D

Properties

BALINIT® D is a chromium nitride (CrN) coating applied by reactive ion plating or arc evaporation. This process is carried out at temperatures of up to 500 °C.

Benefits

BALINIT® D displays a good combination of abrasion, corrosion and oxidation resistance. The coating is markedly harder (about 1,750 HK) than hard chrome and adheres better.

Applications

Large components such as housings and shafts that are not temperature-sensitive are coated with BALINIT® D for the mechanical, automotive and aircraft industries. Coatable materials include titanium and nodular iron but also high tempering temperature steels.

Impact erosive wear

In fluid technology, impact erosive wear is crucial where the flow of abrasive media is controlled. Metal-on-metal sliding is secondary under these conditions. Surfaces and coatings must combine hardness and toughness in order to stand up to this kind of load. Nitride coatings such as TiN or CrN as well as DLC coatings with a nitride support layer (BALINIT® DLC STAR) are best suited to these requirements.

BALINIT® A

Properties

BALINIT® A, a titanium nitride (TiN) coating, is applied by ion plating or arc evaporation, as is BALINIT® D. In contrast to that coating, it employs titanium in place of chromium.

Benefits

BALINIT® A can be used everywhere, offering high hardness (around 2,300 HK), good frictional qualities (friction coefficient 0.4) and stability at high temperatures.

Applications

High tempering temperature steels and some lower tempering temperature steels can be coated with BALINIT® A. The coating is employed where high abrasion resistance is desired, often combined with a decorative function.

BALINIT® FUTURA NANO

Properties

BALINIT® FUTURA NANO is a titanium aluminium nitride (TiAlN) coating, applied by arc evaporation at temperatures up to 500 °C. As against chromium nitride and titanium nitride coatings, it is optimised in terms of hardness (3,300 HK), coefficient of friction, residual stress and maximum service temperature.

Benefits

This coating displays extraordinarily great wear resistance, impact strength and high-temperature stability (up to 900 °C).

Applications

BALINIT® FUTURA NANO is used chiefly for engine components under great temperature stress (valves) and for automotive structural parts subject to severe abrasive wear. Good results are also achieved on components for hydraulic machinery.

Nitride and carbon coatings in impact erosive wear

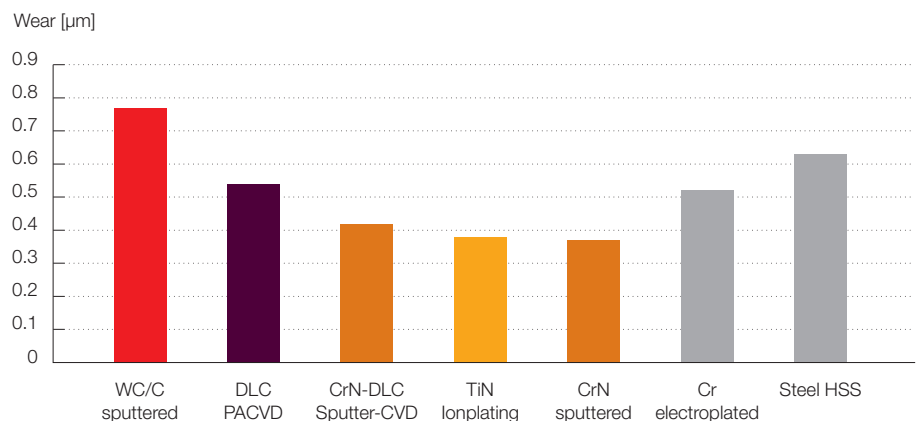

Test: centrifugal impeller
200 µm particles of SiO₂, 80 m/s, impact angle 90°

Advantages of BALINIT® coatings

The characteristic properties of BALINIT® offer many advantages in practical application and thus afford much scope to the designer.

BALINIT®

- **enhances reliability and lengthens service life.** Many mechanical elements perform critical functions, and just a few micrometers of wear can result in failure. BALINIT® wear protection guarantees higher reliability and increased service life.

- **protects dry-running systems.**

The low friction coefficients of BALINIT® permit operation with deficient lubrication as well as emergency operation in case of an undesired loss of lubricant. Coatings also allow systems to function where lubricants are not permissible, as in cryogenic and vacuum equipment, the food industry, clean rooms and space technology.

- **replaces costly materials.**

While the base material provides the needed strength, BALINIT® imparts hardness and good frictional behaviour. This makes it possible to cut costs by replacing expensive materials such as cemented carbides, ceramics and bronze with steel. Examples include cemented carbides in pump shafts, bronze bushings in hydraulic systems or wrist pin bearings in internal combustion engines and the metals used for plain bearings.



Bronze bushing replaced by coating of wrist pin.

- **boosts power and reduces weight.**

BALINIT® coatings come into their own where higher tribological loads and higher mechanical loads occur at the same time. BALINIT® C, for example, enhances the load-bearing capacity of gear wheels, so that they can be made smaller and thus lighter but still handle increased burdens.

- **lessens the need for lubrication and maintenance.**

Oil lubrication drives up operating costs because of the continual need for inspection and maintenance. Lifetime lubrication with grease, however, often fails to meet stringent tribological requirements. A supplemental BALINIT® coating improves tribological performance and greatly lengthens maintenance intervals.

- **reduces the threat of corrosion.**

Thanks to this quality of BALINIT® coatings, severely loaded components can function reliably even in unfavorable environments.

- **eliminates the need for re-machining.** The thinness of BALINIT® coatings and the appropriate temperatures at which they are applied mean no increases in roughness and no uncontrolled dimensional changes of components. Homogeneity and geometrical integrity mean that manufacturing tolerances can be held below 1 µm and make it possible to place coating as the last step in the process when manufacturing precision components.

- **helps protect the environment.**

Lubricants and additives pollute, so areas such as fluid technology are increasingly using water-based hydraulic fluids (HFA fluids) or additive-free lubricating oils. There is also a rising demand for ozone-neutral refrigerants in climate-control applications. When wear problems result from these shifts, BALINIT® coatings offer new solution approaches.

Environmentally benign coating

When you use BALINIT® coatings, you are adopting an advanced technology. In contrast to many conventional coating processes such as phosphating, nitriding, electro- and chemical plating (hard chrome, chemical nickel, etc.), the BALINIT® vacuum process generates no polluting compounds, emissions or residues. If you must meet environmental limits or manufacturing standards, or if you are seeking ISO 14001 certification, BALINIT® coatings can offer new avenues to you.

Limitations of BALINIT® coatings

Advantages aside, there are limits on the use of a BALINIT® coating in some situations:

Replacement for corrosion-resistant steel

The corrosion resistance of a coated component depends on the coating material, the base material, the corrosive medium and the surface roughness of the component. While BALINIT® coatings do enhance corrosion resistance, PVD-coated unalloyed steels cannot replace corrosion-resistant steel, as corrosive media can get through tiny local defects in the thin hard coatings and cause pitting corrosion in the base material.

Continuous dry running

BALINIT® coatings extend the service lives of precision components in all frictional states: hydrodynamic lubrication, mixed friction and dry friction. While the coating permits dry running in emergencies, it does not match the friction coefficient of an oil film and so cannot serve as a long-term substitute for lubrication in severely loaded tribosystems (no cooling action).

Heavy abrasive wear

In spite of their greater hardness, thin hard coatings offer only a marginal improvement where even cemented carbides are subject to tenths of a millimetre of wear.

Unfavourable component geometry

For physical and engineering reasons, coatability is limited when deep holes and deep, narrow slots and grooves (cavities) are present.

Coatability of internal contours

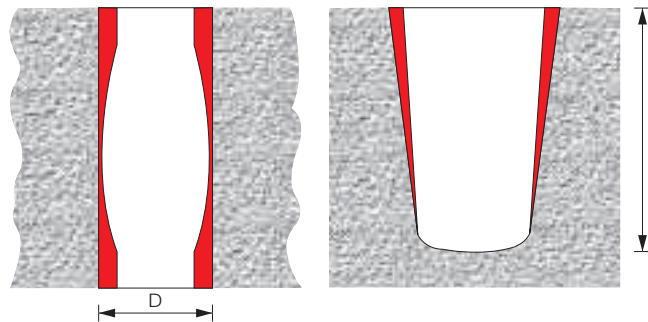

Rule of thumb for acceptable coating adhesion and thickness: Opening (diameter D) should be greater than depth (length L) to be coated.

From problem solver to design element

The performance potential and application range of BALINIT® coatings are far from exhausted. The outcome of coating can be optimised only by an early, comprehensive analysis of the entire tribosystem with all its elements and their properties, as well as the interactions between the frictional partners. The answer lies in the highly developed field of **surface engineering**, which Balzers offers you in the early phases of design.

Coating as a design element

Any user who means to exhaust the full potential of wear-protection coatings must include them in the design phase. This is when the component form, the manufacturing method, and the selection of material and heat treatment can be optimally brought into accord with a highly effective coating. A coating thus affords scope for designing a more powerful system.

Choosing the right materials

There are essentially no limitations on the coating of steels by PVD and PACVD processes. For each material used, the temperature of the final heat treatment - usually the tempering temperature in the case of steels - must be higher than the coating temperature, since coating is the last step in manufacturing.

Mechanical engineers commonly select hardened unalloyed steel (such as ball-bearing steel AISI 52100/DIN 1.3505) for severely loaded parts. This represents a good compromise between economics and strength. Process definitions for the most important PVD and PACVD coating processes take this factor into account. These coatings are applied in the range of the tempering temperature between 150 and 250 °C. Good coating adhesion requires that the temperature be a minimum (approx. 100 to 150 °C) at the start of the process. The temperature can rise in the course of coating, depending on the part dimensions and batch loading. But the coating temperature should not exceed the tempering temperature by much, if at all, so that the hardness will not be unduly reduced. In practice, a somewhat

Coordination of tempering and coating temperatures

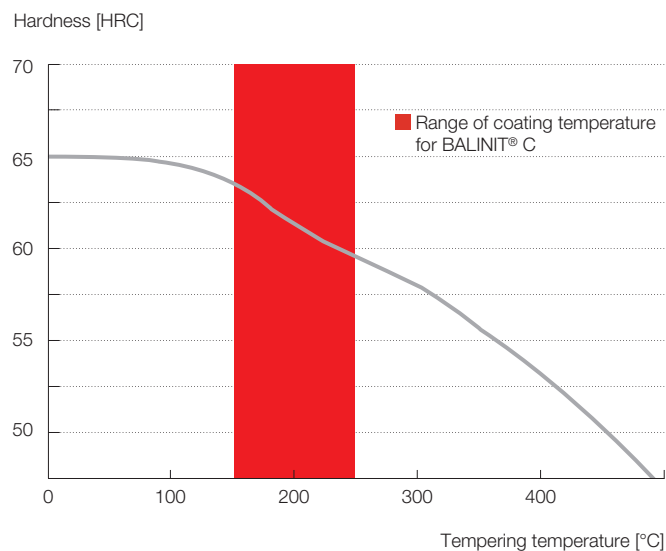

Tempering diagram for AISI 52100 / DIN 1.3505

higher temperature and a slight loss of hardness (2-5 HRC) may well be accepted for the sake of a robust process and good coating adhesion. It is recommended that these values be set down and documented in quality agreements.

The following pages offer suggestions on the selection of a suitable material and on how to design, pretreat and conserve components in the right way for coating.

Materials and their coatability

Steel

Ball- and **roller-bearing steel**, **case-hardening steel** and **special-purpose tool steels** are typical materials for precision components. These and other low tempering temperature steels can be coated at temperatures up to 200 °C. Typical representatives include AISI 52100 (DIN 1.3505) and AISI 5115 (DIN 1.7131).

Heat-treatable steels and **higher tempering temperature tool steels** such as AISI M2 (DIN 1.3343) and HSS pose no problems for coating. The lower hardness of heat treatable steels, however, means that they are not often employed for precision components.

Nitrided steels can be coated, but the porous parts of the compound layer (white layer) have to be removed first. Components must be lightly re-ground or microblasted before coating. The most common nitriding processes are gas-phase, salt-bath and plasma nitriding. The plasma process provides the best basis for subsequent PVD or PACVD coating because the formation of the white layer can be suppressed in this process.

Austenitic steels can be hard-coated by all PVD/PACVD processes. With these soft steels it must be considered that while thin coatings reduce friction and wear, they do not increase the resistance to deformation.

General-purpose engineering steels can be coated with all PVD and PACVD hard coatings, but these typical structural steels, with lower strength and supporting action, are seldom used for precision components.

Cast iron

From the standpoint of temperature, **cast iron** is well-suited to coating. The tribological qualities of the component can be improved by coating, but graphite inclusions in the base material affect the coating structure.

Nonferrous metals

Nickel and **titanium alloys** are readily coatable and are used primarily for special applications such as corrosion protection and lightweight construction.

Copper, magnesium and **aluminium alloys** are coatable in special cases. The age-hardening conditions are an important factor in alloy selection. Hot age hardening at the highest possible temperature is recommended. Nonferrous alloys have low hardness and supporting action under high surface pressures, so their use is restricted to loads that the materials can handle.

Brass can only be coated after chemical nickel-plating.

Aluminium alloys display natural or artificial (hard anodised) oxide films. There are two options for coating aluminium alloys without hard anodising: preliminary chemical nickel-plating (a thickness of 5 µm is sufficient) followed by standard coating processes, or the use of special processes if no chemical nickel is applied.

Chrome-plated and nickel-plated metals

Such electroplate/PVD composite coatings, in which the electroplated layer has limited adhesion to the substrate, are best employed under combined corrosion and wear conditions where mechanical loads are not too severe.

Sintered materials

As a rule, **cemented carbides** can be coated without any restriction but mechanical operations such as grinding must be modified as appropriate. Cemented carbides should be machined with coolant-lubricants containing cobalt inhibitors. **Sintered metals** with open pores cannot be coated because residues from the sintering process outgas in vacuum, interfering with the plasma processes.

Other materials

Suitable **ceramics**, that is, conductive or metallised ones, can be coated. Oxide ceramics such as aluminium oxide need special processes that permit coating application even though an insulating surface is present.

Because of their lack of conductivity and their sensitivity to high temperatures, **plastics** are not coatable with BALINIT®.

Coatable materials

Materials	BALINIT® C a-C:H:W	BALINIT® DLC a-C:H	BALINIT® CNI CrN	BALINIT® D CrN BALINIT® FUTURA NANO TiAlN	BALINIT® A TiN
Steels with heat-treatment temperatures > 500 °C					
Heat-treatable steels	+	+	+	+	+
Cold-working steels	+	+	+	+	+
Hot-working steels	+	+	+	+	+
High-speed steels	+	+	+	+	+
Austenitic steels	+	+	+	+	+
Age-hardened steels	+	+	+	+	+
Steels with heat-treatment temperatures around 200 °C					
Ball- and roller-bearing steels	+	+	+	□	□
Case-hardening steels	+	+	+	□	□
Hardenable chrome steels	+	+	+	□	□
Low tempering temperature tool steels	+	+	+	□	□
Other materials					
General engineering steels	+	+	+	+	+
Nitrided steels (after pretreatment)	+	+	+	+	+
Cast iron	□	□	□	□	□
Chrome-plated metals	□	□	□	□	□
Nickel-plated metals	□	□	□	□	□
Nickel alloys	+	+	+	+	+
Titanium alloys	+	+	+	+	+
Copper alloys	□	□	□	□	□
Aluminium alloys	□	□	□	□	□
Cemented carbides	+	+	+	+	+
Sintered metals (after pretreatment)	□	□	□	□	□
Ceramics	□	□	□	□	□
Plastics	-	-	-	-	-

- + coatable
 - not coatable
 □ conditionally coatable (inquire)

Hardness and strength of materials

The hardness and load-bearing capacity of materials play a special role in coating because typical PVD/PACVD coatings are not self-supporting. A hard substrate offers adequate supporting action for the coating and prevents it from breaking up ("eggshell effect").

Therefore as a **rule of thumb**, to apply a coating, the greater the load on the component, the harder the substrate material must be (> 45 HRC). Plasma nitriding or case-hardening of soft steels can produce a boundary zone that will support the coating. If subsequent loss of hardness is to be avoided, the tempering temperature must be higher than the temperature at which the component is coated. Do not reduce the substrate hardness of the component to be coated. Furthermore, it is advisable to coat the harder surface in the tribosystem.

Component surface quality

Along with strength, the surface condition of the component affects coating performance. A necessary condition for good coating in a vacuum process is therefore:

A readily coatable component is one that has been ground or polished, well cleaned, and conserved for shipping.

The following details should be kept in view:

- Surfaces must be metallicly bright. Corroded, brown-finished, steam-blued or similarly treated surfaces cannot be coated.
- Ground surfaces must not display burrs, grinding cracks, oxide skins or rehardening burns.

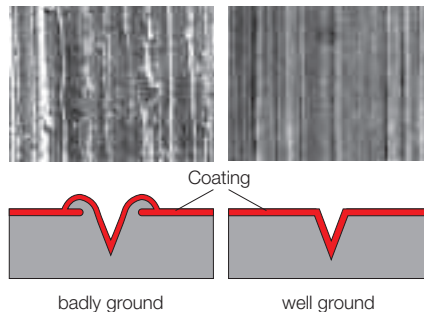

- Coolants employed in grinding must not contain calcium sulfonates, compounds of boron or iodine, or silicone-based antifoaming agents.
- Ground, honed, polished or lapped surfaces must be cleaned of abrasive compounds and their residues.
- Brazed and soldered joints must be free of pipes, fluxes and cadmium.
- Blind holes and internal threads must be free of hardness salts and other contaminants.
- Chips, wax, adhesive tape, paint and other nonmetallic contaminants must be removed from the components, also grinding dust, cleanser residues, fingerprints and the like.
- The components must be demagnetised.

Roughness plays a central role in friction and wear processes. The smaller the roughness, the better the tribological properties. Improving the surface quality, however, comes with costs as well. This is true for both uncoated surfaces and those that will receive coatings. For severely loaded precision components, designers specify the well-ground surfaces ($R_z = 0.5-5 \mu\text{m}$). PVD coatings follow the surface topography exactly, and there is just a very small increase in roughness.

A roughness in the high range (i.e., 3 to 5 μm) can be chosen when applying "softer" coatings such as BALINIT® C (WC/C, approx. 1,000 HK), thanks to the very good running-in and burnishing qualities and the good behaviour towards the mating part. With hard nitride and DLC coatings, the roughness R_z should be between 0.5 and 1 μm to avoid unduly great wear to the mating part.

The increase in roughness with PVD coatings is generally negligible. There is an increase of approx. 0.2 μm in R_z with sputtering, evaporation and PACVD processes, and approx. 2 μm with arc coating. Methods such as blasting or brushing have become standard in order to remove roughness peaks (droplets) after arc coating.

Coated surface = functional surface

The designer can exert a good deal of control over unit coating costs by taking into account the coating from the very beginning of the component design process. The configuration is best if only the component with the functional surface has to be coated - that is, other surfaces of the component are not coated needlessly and no expense is incurred in masking them off. The illustration shows an example. If the functional surface of the worm is rigidly attached to the shaft stubs, the entire component must be coated. A better solution is to make the worm and stubs separately. This approach saves space in the coating machine and thus optimizes the number of components per batch. The two parts can be joined or press-fitted together after coating.

Component design for coating

The best coating results will be achieved if component condition and geometry are in harmony with the physical and engineering conditions of cleaning, preparation and coating.

Component condition

- Components are fixtured for coating. Allowance should be made for the surface covered by the fixture, which will remain uncoated.
- Surfaces that must be left uncoated are covered by a mechanical mask. Optimal component design must permit this, since the use of pastes (as in nitriding) is not possible.
- Preassembled (glued, screwed or pressed together) components cannot be coated. The joint surfaces will outgas in vacuum and may not lend themselves to adequate cleaning. Welded structures must be put through a stress-relief anneal before coating.

- Blind holes can be coated, but they should not have a depth greater than their diameter.

Geometry, dimensions and weights

In addition to the condition, the geometry and weight of the component must be considered. The maximum size and weight of a component for coating depend on the coating selected. The maximum weight is about 3,000 kg, or a diameter of 1,300 mm and a length of 1,500 mm.

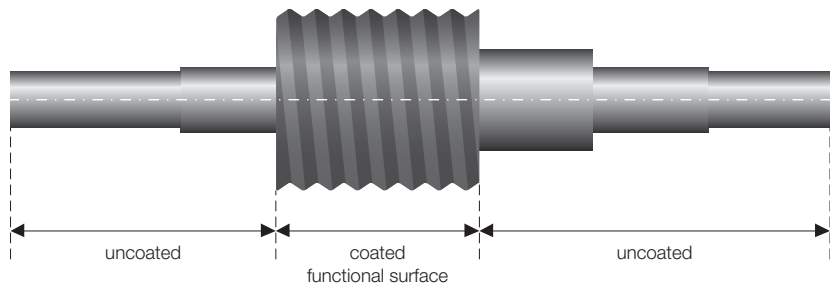

A component not designed for coating: Fewer units per coating batch, need for masking.

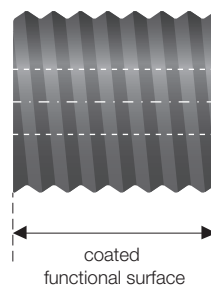

A component designed for coating: More units per coating batch.

Conservation and packaging

The parts must be guarded against rusting in the course of transport. This can be done by treating them with a slight water-displacing oil, which can be removed without residue by alkaline cleaning after delivery. An alternative is VCI (volatile corrosion inhibitor) paper in a vacuum package. Undiluted oil, grease or wax should not be used. These conserving agents are difficult to remove and would interfere with the sensitive baths used in cleaning systems.

When emulsion coolants are used in manufacturing, it is essential to clean components thoroughly before conservation. This must be effected in an aqueous process using deionised water. Otherwise, water hardness can result in lime deposits on the parts; such deposits can combine with the conserving agent to form durable surface residues that cannot be removed by chemical means.

The use of oils in fabrication processes has proved not to be a problem, because there is less danger of residues on the parts.

Proper packaging guards components from harm due to external factors and keeps them from damaging one another. A packaging that is also suitable for repeated use and for return shipment is advisable.

For mass-production parts we recommend consulting with us on fabrication media and packaging. We shall be glad to assist you.

Optimal coating results do not depend solely on component design. The choice of the right coating for the application is also crucial to boosting component and system performance, as the next chapter will demonstrate. Balzers offers both proven, standard solutions and customised coatings for specific needs.

Application tailored solutions

The chief objectives of today's designers and design engineers as they work out new and innovative concepts include lighter weight, higher output from more-compact mechanisms, lower emissions, and minimal lubrication and maintenance. As requirements on systems grow more stringent, so do requirements on their components, and classical materials soon reach their limits. Potential for performance can be greatly enhanced with application-tailored BALINIT® hard coatings; indeed, only BALINIT® makes new design solutions feasible in many cases.

Engine technology

Boosted fuel economy, reduced emissions, greater power and passenger comfort are among the challenges that have led vehicle and engine developers toward innovative engine designs:

- Gasoline engines with direct fuel injection, variable valve timing, smaller displacement and turbo charging, as well as fuel-cell hybrid technology
- Diesel engines with high-pressure injection, soot filters and exhaust gas recirculation and capable of running on low-sulphur fuels

Drastic testing in motor sports is often a first step toward the adoption of coated components in the automotive industry. Mechanical components for racing service are designed for maximum strength and must be as light as possible at the same time. BALINIT® coatings are crucial for the reliable functioning and long life of these components in hard racing service.

Engines

Design innovations aimed at boosting efficiency, such as lighter aluminium engine blocks, are costly in terms of development. Less effort has been focussed on cutting internal friction and how this will affect power output. Frictional losses in engines occur at piston/connecting rod joints, crankshafts, valve trains and oil pumps, among other places. A reduction in

friction will bring about not just greater output but also a potential for lower fuel consumption and emissions. Solutions based on BALINIT® carbon or metal coatings have proven themselves both in automotive production and in racing. The very good wear and friction behaviour of these coatings improves the performance and service life of engine components such as tappets, wrist pins and piston rings.

Wear of diesel truck engine by parts

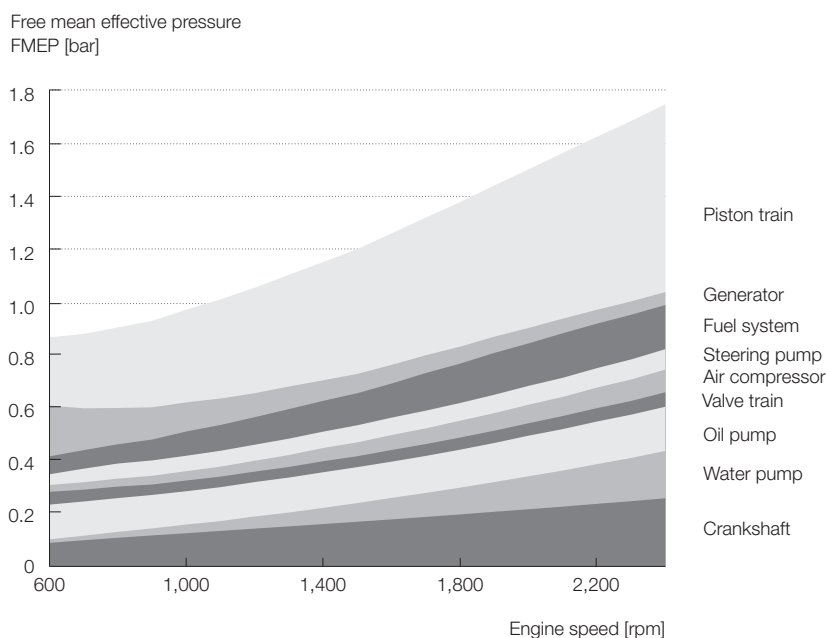

This test programme result shows how much friction loss is due to individual engine components and thus how these components affect fuel consumption in a truck diesel engine.
Source: IVECO Motorenforschung AG

Valve train

BALINIT® C and BALINIT® CNI are recommended for the coating of tappets in high volume production. The WC/C coating displays its special advantages in low friction, while the CrN coating stands out chiefly in the good wettability of the very fine sur-

face. With regard to service life and wear, both coatings are far superior to conventional phosphating. BALINIT® coatings have found acceptance in motor sports for friction and wear reduction. BALINIT® DLC STAR is used on a large scale for the coating of cam followers and tappets.



Coating of engine parts reduces friction and thereby increases the output and efficiency of the drive system.

Friction reduction in the valve train of a passenger car with carbon coating of tappets

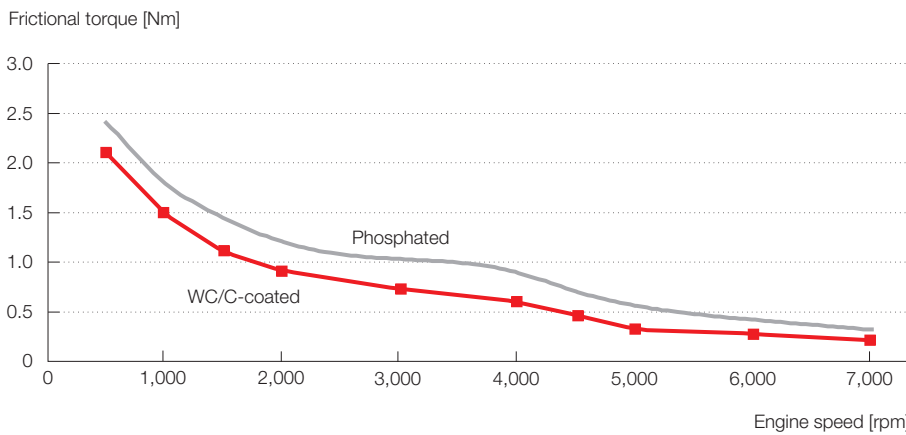

Test method: Cylinder-head test stand, non-fired
Source: Ford/INA

Measurable advantages are also gained in truck engines. Tappets coated with DLC were tested on an engine test stand. They proved to reduce frictional power consumption by as much as 400 W in comparison with uncoated cast-iron tappets at higher speeds.

Reduced valve-train power consumption with BALINIT® DLC-coated tappets (truck engine)

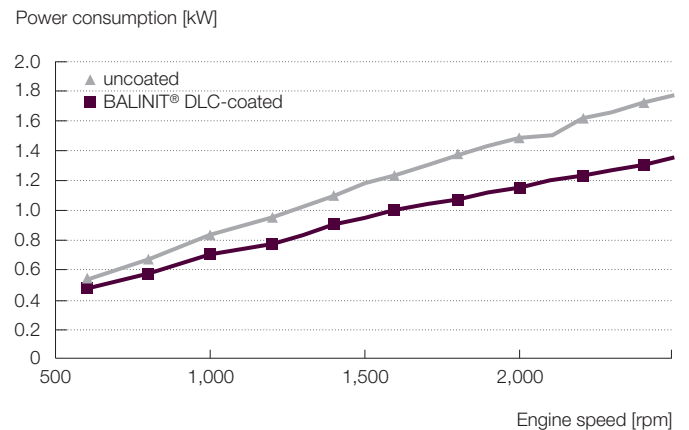
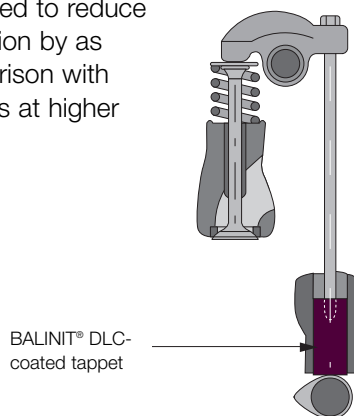

Piston rings

Piston rings cause significant frictional losses in engines, while being subject to added wear as a result of rising ignition pressures and exhaust gas recirculation. For this reason, a wide variety of anti-wear coatings offer potential improvement. Electroplated coatings with fine dispersed carbides

and PVD coatings are finding greater and greater acceptance along with the proven coatings for piston rings, such as hard chrome and molybdenum, plus nitriding for steel rings. A benchmark trial has shown that BALINIT® C is among the best solutions. In a comparison with the most important standard coatings, BALINIT® C displays the least ring and cylinder wear.



Wear of cylinder liners with variously treated piston rings

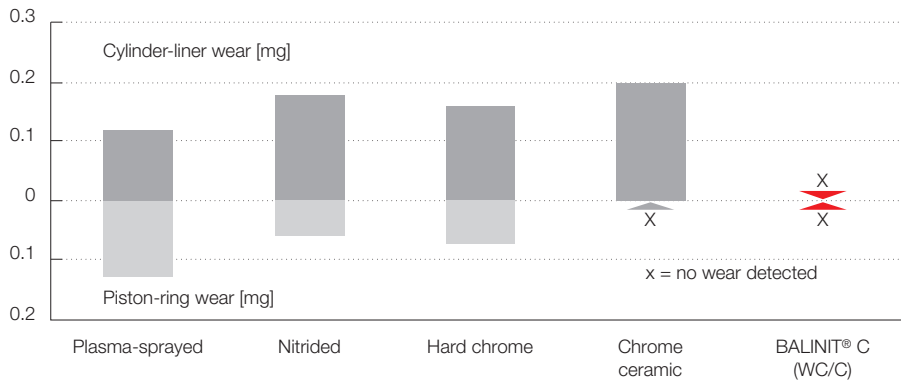

Tribometer: Cameron-Plint TE77
 Load: 8 MPa
 Temperature: 80 °C
 Test duration: 6 h
 Frequency: 10 Hz
 Cylinder liners: Grey cast iron
 Oil: Lubrizol TH 53303

Treatments applied to piston-ring surface only

Source: Scania AB

A simulation with passenger-car piston rings showed that PVD-CrN and PVD-WC/C sustained greater loads in the scuffing test than hard-chrome-coated or nitrided rings. What is more, CrN displayed the lowest wear while friction was least with WC/C. An engine test provided impressive confirmation of these results, with WC/C and CrN cutting the frictional power consumption (at 2,000 rpm) by 9-20 % in comparison with hard chrome coating and nitriding.

Friction and wear tests on piston rings (passenger car)

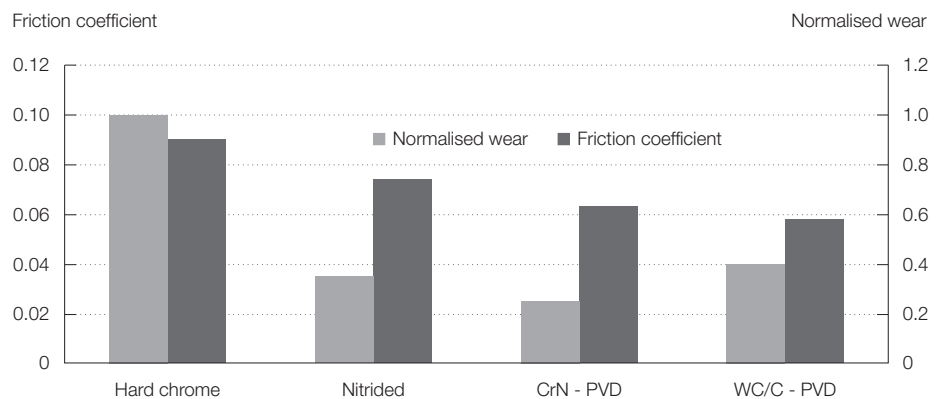

Test conditions (model test):
 Wear test: 100 N, 600 cm/min, 60 min
 Friction test: 100 N, 100 cm/min
 Lubricant: oil
 Cylinder liner: cast iron

Results on piston rings in two-stroke engines for recreational and sport vehicles were similarly convincing. Some chrome dispersion coatings (even those established in the field) were not up to the challenge of this application, failing by heat checking. A series of tests was dedicated to comparing a variety of PVD coatings: Here sputtered CrN coatings (BALINIT® CNI) showed the lowest wear. They are applied in a thickness of 10 µm in series.

In addition to replacing conventional coatings for piston rings, DLC and WC/C coatings are also employed as running-in coatings on nitrided, chrome-plated or flame-sprayed piston-ring surfaces.

Wrist pins

The high injection and combustion pressures typical of today's diesel and racing engines mean very severe pressures where the wrist pin is in contact with the small eye of the connecting rod. Bronze bushings, which are commonly used as wrist-pin bearings, can well reach their strain limit. BALINIT® DLC or BALINIT® DLC STAR coatings on the wrist pins take over the friction-reducing function of the bushings and render them superfluous. These coatings also permit a lighter, stiffer connecting rod design. What is more, BALINIT® coatings effectively prevent scuffing of material in the wrist-pin hole of the aluminium piston.

Piston ring wear in two-stroke engines

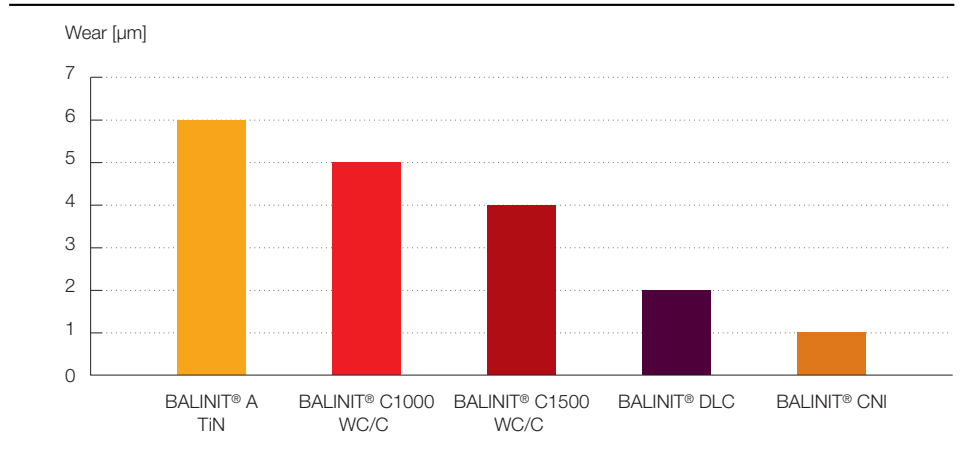

Running time: 50 hours



When wrist pins are coated by PVD processes, not only the bronze bushing becomes unnecessary and the wear is reduced. There is also a marked reduction in friction and thus in engine power consumption. Frictional power consumption, measured at high revolutions and high ignition pressure, was cut by as much as 600 W in a test rig.

Reduced friction with BALINIT® DLC-coated wrist pins (truck engine)

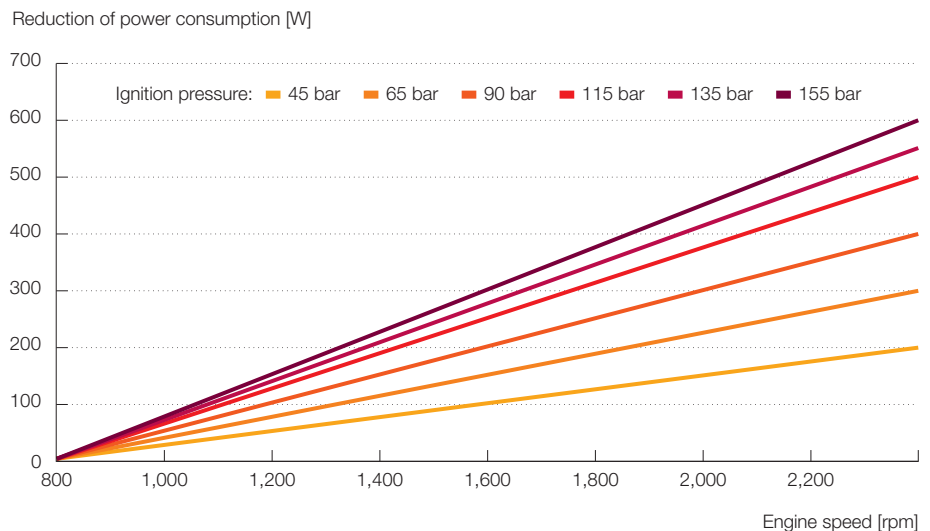

Motor sport

Innovations in motor sport often foreshadow mass-production applications in automaking. This holds for coatings as well. A variety of PVD-coated components have long been used in nearly every category of motor sport, above all in the valve train, piston group, transmission and chassis and suspension parts.

Wear and friction reduction in motorcycles

The coating of tappets, finger followers, wrist pins and transmission parts in sport motorcycles yields improved wear resistance as well as gains in power. A dynamometer test showed a 2.2 % power increase for a Kawasaki Ninja. Today mass-produced wrist pins and finger followers are coated with BALINIT® DLC.



Friction reduction

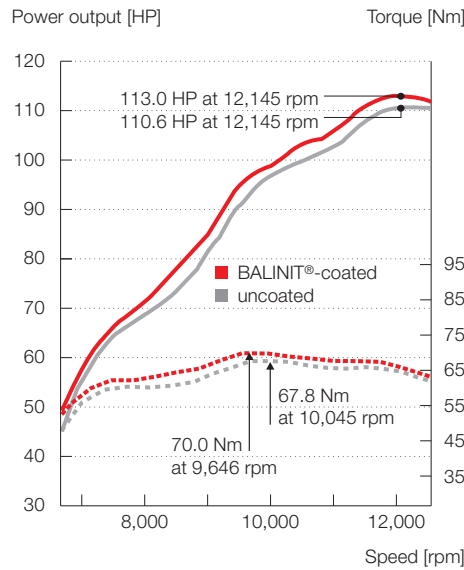

Motorcycle: Kawasaki Ninja
 Parts coated:
 Tappets: BALINIT® DLC
 Wrist pins: BALINIT® C (WC/C)
 Transmission: BALINIT® C (WC/C)

Power gain: 2.4 HP = 2.2 %
 Increase in torque:
 2.2 Nm = 3.3 % at lower speed



Tappets from a Kawasaki racing motorcycle.
 Left: uncoated, after approx. 250 km; severe wear necessitates replacement.
 Right: BALINIT® DLC-coated, after approx. 1,000 km; almost no wear; still in service.

Shock absorbers

The coating of shock absorbers is not just a matter of appearance. The excellent sliding properties of PVD coatings also lead to better response (reduced stick-slip) and improved anti-diving behaviour. The coatings used are TiN, DLC and TiAlN.



BALINIT® FUTURA NANO (TiAlN)-coated motorcycle shock absorber tube

Formula 1

Formula 1 racecars could not compete without thin hard coatings. DLC and nitride coatings are applied to engine parts under extreme loads, such as camshafts, finger followers, valves and connecting rods, in order that they can withstand high speeds and high surface pressures and meet the need for longer service life.

The small eyes of connecting rods are coated in order to allow operation without bushings. In most cases the frictional partner of the small eye is a DLC-coated wrist pin. The lateral surfaces of the connecting rods are coated so that frictional losses at the crank arms can be reduced to the greatest extent possible.

Valves experience severe loads at seat, tip and shank. Ductile CrN coatings (such as BALINIT® CNI) have proven serviceable for exhaust valves, WC/C or DLC for intake valves. DLC coatings, commonly over a nitride base layer (e.g., BALINIT® DLC STAR), are employed in the valve train.

Furthermore, a long list of steering and suspension parts, as well as threaded connectors made of titanium, receive WC/C or TiN coatings.

Titanium parts can be additionally oxidised in a special process (Ti-Plus). Along with a TiO_2 layer, an oxygen diffusion coating typically 10-15 μm thick is applied; the latter affords good support to the rather soft titanium alloys. This process has found accept-

ance for valve spring retainers among other parts, but it is ideally suited to internal surfaces (holes) as well.

Where service conditions are critical, piston rings can no longer reliably hold the aluminium pistons away from the cylinder walls. Carbon coatings on the aluminium pistons eliminate the danger of seizing. Coating the piston-ring grooves simultaneously provides effective protection against cyclical frictional wear due to the side flanks of the piston rings.

BALINIT®-coated parts for motor sport



Fuel injection

Innovative diesel injection systems such as unit injector and common rail were milestones in engine technology. Injection pressures in diesel engines have risen to 2,000 bar and beyond, and these systems provide both optimal fuel utilisation and improved engine emission values. The high pressures however, impose extreme stresses on conventional materials used for injection system components and unacceptable wear can result. Increased contact forces and correspondingly narrow lubrication clearances make lubrication more difficult, further promoting wear.

These processes have the following consequences:

- Plungers and injector needles must be manufactured to a tolerance of less than 1 μm in order to prevent leaks in operation. Acceptable lifetime wear rates are in the order of tenths of a micrometre.
- The prevailing pressures exert such stresses on hardened steel bearing components that scuffing may occur.
- Classical materials such as bronzes in plain bearings can experience plastic deformation.

BALINIT[®] carbon coatings offer qualities that enhance the performance limits of the materials and protect severely stressed precision components against adhesive and abrasive wear. At the same time, these coatings have ideal emergency running properties, so that operating life is extended even under starved lubrication conditions. In practice, these coatings help boost effective engine output, lengthen maintenance intervals, and reduce fuel consumption and emissions of soot and other pollutants.

Mass-produced BALINIT[®] C, BALINIT[®] DLC and BALINIT[®] DLC STAR coatings have become indispensable for the functioning of injectors, plungers and plain bearings in common-rail and unit injector systems. Hard coatings, however, have been in service even longer, for example in in-line and distributor pumps employed in commercial vehicles, marine diesel engines and stationary power plants.

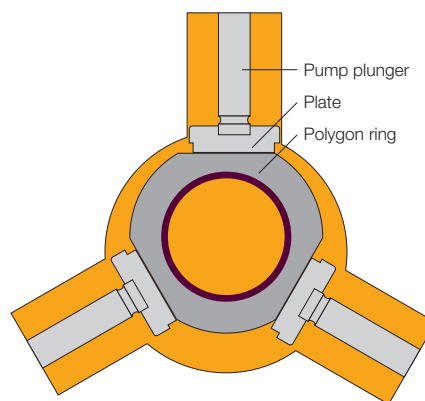

Schematic drawing of a diesel injection pump



BALINIT[®]-coated polygon ring for a diesel injection pump

Common-rail injectors

BALINIT® DLC sets a new standard in common-rail systems. The hard carbon coating provides great abrasion resistance for the tribologically stressed components in modern common-rail injectors. These components must handle high surface pressures and at the same time stand up to severe abrasive stress due to ultrafine particles in the fuel. BALINIT® DLC gives these components the needed service life.



Service life of common-rail injector plungers

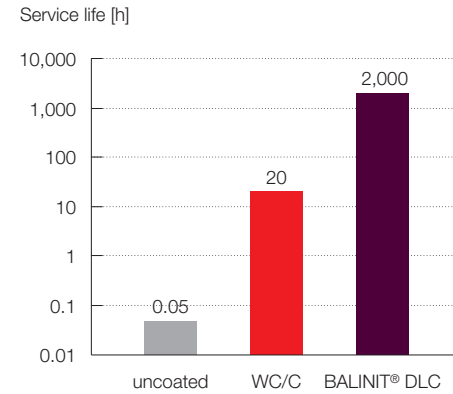

Test conditions
Material: AISI 52100 (DIN 1.3505) bearing steel
Criterion for stopping test: Material wear of 1 µm
Diesel injector under accelerated operating conditions

Pump plungers for marine, locomotive and utility vehicle applications

Since the 1980s, Balzers has applied PVD coatings to plungers for in-line, distributor and single-cylinder pumps used in marine diesel engines, engines for construction machinery and stationary plants (emergency generator systems). These applications feature the use of heavy oil and contaminated fuels, leading to premature wear and high maintenance costs. For this reason, original-equipment plungers in the injection pumps of large engines are coated with BALINIT® C or BALINIT® DLC, which contributes to better economy and lower emissions.



Unit-injector system: plain bearings

The BALINIT® C carbon coating strengthens many components in the unit-injector system, such as the plain bearings that transfer the motion from cam to plunger. In a floating system with a pin, a bushing and a roller, the pin and bushing are coated with BALINIT® C to safeguard against wear.



Mechanical drives

The design of drive components for vehicles and machinery is marked by trends such as the use of lightweight construction, higher efficiencies, more severe loads, lower lubricant consumption and longer maintenance intervals. These requirements tend to increase the wear of bearing and transmission components. Alternative material selection can only rarely meet these challenges.

Vehicle gears

Wear modes and causes of failures in gear transmissions depend on the load and the peripheral speed:

- **Sliding wear** occurs at low peripheral speed when there is no continuous lubricant film between the tooth faces, so that the surfaces come into direct contact (mixed friction).
- **Scuffing** can come about at low peripheral speed when loads are more severe. This process can also result if the viscosity and thickness of the lubricating film decrease with rising peripheral speed and temperature, so that the lubricating film ultimately ruptures. Scuffing is commonly preceded by wear to the tooth faces.

Wear-protection coatings offer a different approach. Their use guards components against scuffing and pitting and extends their service lives, thus making the whole system more durable.

The BALINIT® C carbon coating, for example, has proved its worth in the planetary transmissions of construction machinery and commercial vehicles, in the emergency operating reserve of

helicopter transmissions, and in racing transmissions, where it reduces friction and boosts power. Another application area where coating protects against surface fatigue, tribo-oxidation, brinelling and also permits unlubricated operation is for rollers and races in industrial roller bearings, which experience very severe loading.

- **Pitting** is a further possibility if a load-bearing lubricant film is present but the loading capacity is limited by the compressive strength of the gear surface. Due to continuous cyclic loads at high contact pressures, fine cracks are produced at grain boundaries or at inclusions beneath the surface. These cracks lead to detachment of particles from the surface, leaving small pits on the tooth faces.

- **Micropitting** is attributable to starved lubrication. Microscopic cracking and chipping give the visual impression of gray spots.

The use of case-hardened steels virtually exhausts the load-bearing capacity of gears. The danger of scuffing is mitigated by additives in the gear oil. Carbon coatings, however, are more effective against all wear mechanisms in transmissions.

The BALINIT® C (WC/C) coating in particular separates metallic gear surfaces reliably under mixed friction conditions.

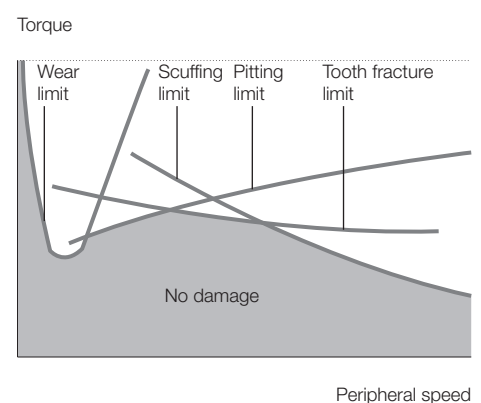

Service limits of gear drives

The danger of scuffing and micropitting is reduced, while the maximum load capacity (pitting resistance) is increased compared to case-hardened gears. A source for this improvement lies in the excellent running-in behaviour of BALINIT® C. The coating reduces local surface pressures (Hertzian pressure) and enhances the reliability of poorly lubricated gears.

High-speed spur gears

BALINIT® C quadruples the service life of gears. The standard FZG C test shows that the fatigue strength is increased by 10-15 % over case-hardened but uncoated gears. In the test the failure criterion for gear service life was defined as single-tooth wear of 4 % due to pitting. The key factors in these improved figures were the lower local surface pressure (Hertzian pressure), which resulted from reduced friction in the rolling contact, and the outstanding running-in behaviour of BALINIT® C.

High-speed gears in severe service

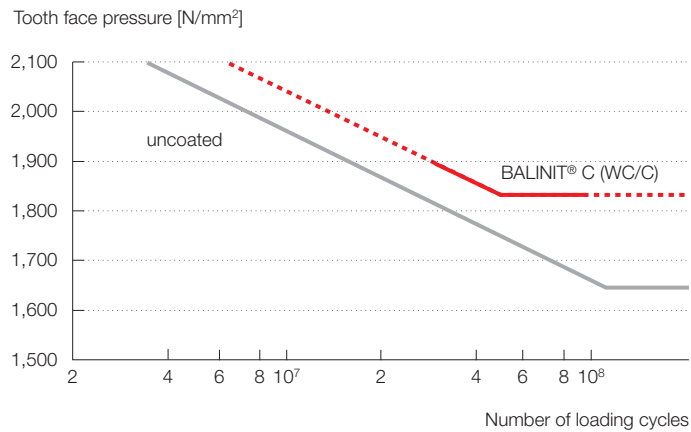

Test method: FZG C test
 Material: Case-hardened steel
 Hardness: 62 HRC
 Roughness: R_z = 3 µm
 Criterion for stopping test:
 4 % material loss per tooth
 (weight) by wear

Uncoated transmission gear:
 surface fatigue (pitting) despite
 continuous lubricant film

Pitting wear with combined surface treatments

PVD coating is not, however, the only option for increasing the pitting resistance of gears. Other treatments include combined case-hardening and nitriding (duplex treatment) and surface polishing by the Vibrofinish process. Gears show marked gains in pitting resistance and service life as a result of both PVD coating with WC/C and duplex treatment, but the best results come about with a combination of Vibrofinish and WC/C coating.

Rolling-contact fatigue test

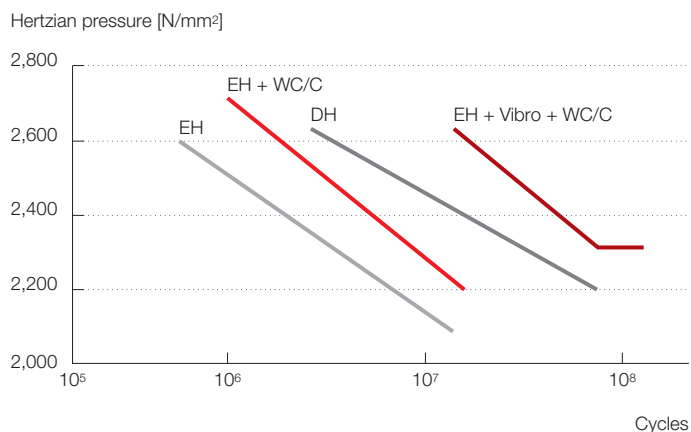

EH: case-hardened, 0.7-0.9 mm
 DH: duplex-hardened, 1,050, HV10
 WC/C: BALINIT® C-coated, 1,000 HV / 2 µm
 Vibro: Agusta superfinish, R_a 3.2 / 0.6 µm

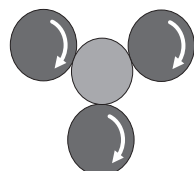

Test conditions:
 Oil: Mobil Jet / 80 °C
 Sliding/rolling ratio: 24 %
 Speed: 2,860 rpm
 Material: M50 Nii / > 700 HV
 Source: J. Kleff and D. Wiedmann,
 ZF Asset Brite Euram Project

Gear wear by scuffing

Scuffing, a consequence of starved lubrication, is an important mechanism of gear wear. Simulating the process on the test stand involves supplying only very small quantities of lubricant and comparing the results with coatings. Experiments at the IMM (Institute of Machine Elements and Machine Design) at the Technical University of Dresden have shown that service life can be significantly extended by either light lubrication or a WC/C coating, but the best results are obtained with a combination of the two. This means on the one hand that coating cannot supplant regular lubrication, but on the other hand that lubrication and WC/C coating act in a positive synergy.

Spur gears for motorcycles

The practical impact of protecting gears against scuffing was illustrated by an emergency that occurred during a motorcycle race. The transmission was threatened with scuffing due to a loss of oil, but amazingly the rider was able to finish the race thanks to coating of the most severely stressed gears. An analysis showed that the uncoated gears had perceptible wear marks but the coated ones displayed virtually no abrasion.



Gears from a motorcycle spur gear transmission after loss of oil: BALINIT® C (WC/C)-coated (left), uncoated (right)

Gear wheel wear in dry running and starved lubrication

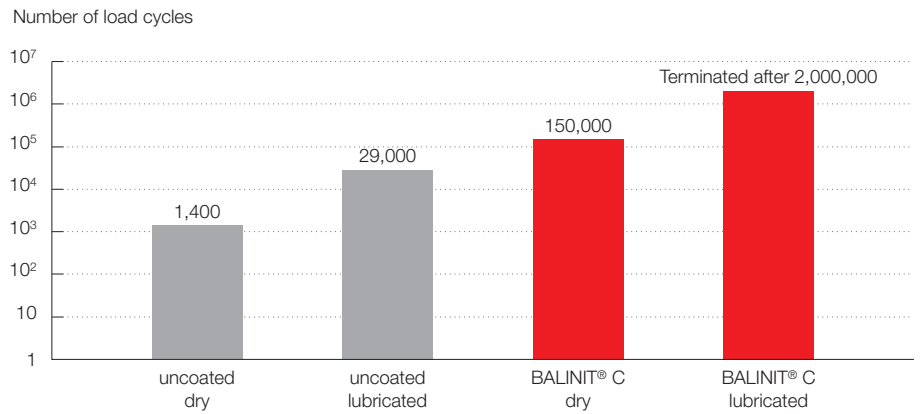

FZG test

Speed: 1,000 rpm
 Surface pressure: 1,000 N/mm²
 Lubricant: Esso CL46B (plant-based)
 Lubricant feed rate: 1 drop per minute
 Source: IMM (TU Dresden)

Planetary gear set for concrete mixers

A quite different kind of load causes wear in the planetary gears of concrete mixers. The very low speed and the simultaneously high surface pressure mean that no lubricant film can form, and the sun wheel, the most greatly stressed component, is subject to severe abrasion. With BALINIT® C (WC/C) coating, wear is practically brought to a halt after a running-in phase.

Model test: planetary gears

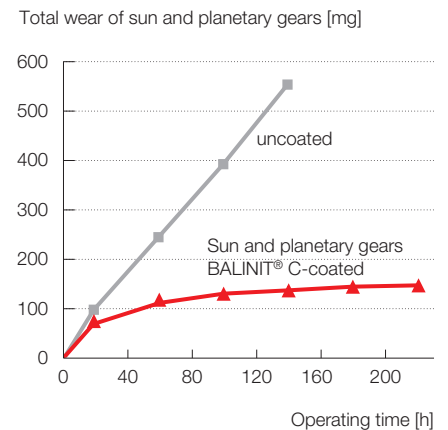

Test conditions:
 Gear tooth profile: FZG-C
 Low-speed wear
 Load: 2,180 MPa (316 KSI)
 Sliding speed: 0.04 m/s

Transmissions for aircraft

For weight reasons titanium alloys are replacing steel more and more in gears. The low hardness and poor adhesive wear resistance of Ti-alloys can be overcome by using BALINIT® C.

But also steel gears benefit from BALINIT® coatings. E.g., helicopters must have the ability to run under emergency conditions (transmission fluid loss) long enough to land safely. Tests of carburised steel helicopter transmissions revealed an increase from a scant hour to over six hours of emergency reserve with BALINIT® C coating.

Helicopter transmission

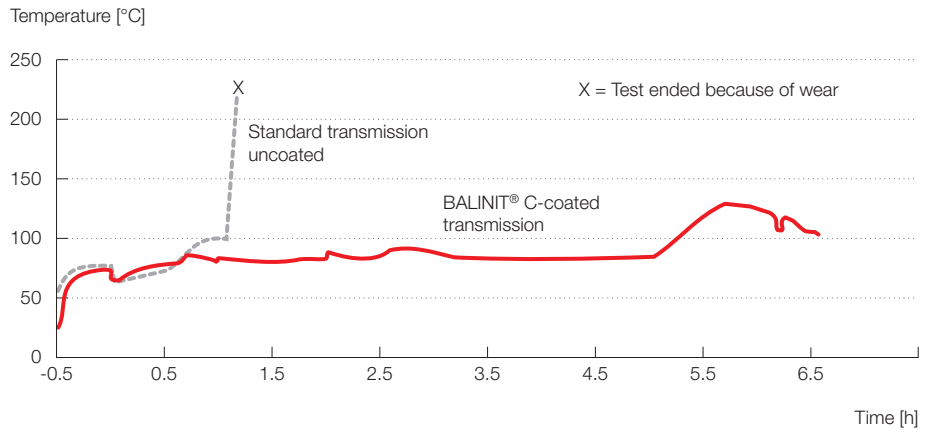

BALINIT® C-coated gears permit emergency operation for a considerably longer time after a loss of transmission fluid.
Source: P. Maret and C. Varailhon / EUROCOPTER France

Torsen differentials

The performance of differentials in passenger cars is impaired by friction and wear arising chiefly on cold starting. Engineers are successfully improving reliability with WC/C coatings.

Rear-axle gearboxes in trucks

Very great friction develops in truck rear-axle gearboxes with spiral bevel gears. Development engineers have therefore studied whether PVD coatings could cut this friction. They found that frictional losses could be reduced by 1-1.5 kW (depending on the oil temperature) with WC/C coating.

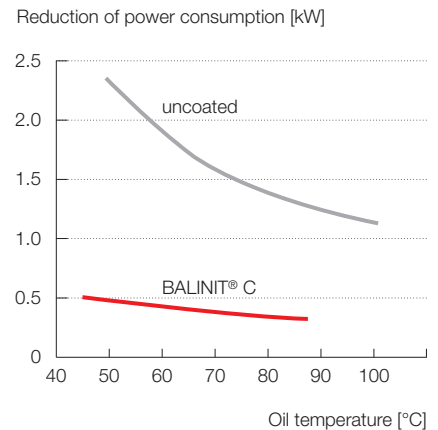

Reduction in truck rear-axle power consumption by BALINIT® coating

Gear ratio: 2.93
Speed: 1,100 rpm

Industrial drives

Worm gears with coated worm

Lubrication is not always enough to protect helical-gear transmissions, which are coming under more and more severe stress, against friction and wear. Worm systems, for example, work under very unfavourable tribological conditions. The sliding motion and the force between the worm and gear faces make it difficult for a lubricant film to form. For this reason, the gear is most often made of bronze in order to avoid scuffing. In service, however, the teeth of the bronze gear wear away quickly and the gear must be realigned or replaced. Carbon coatings can improve the reliability and performance of worm drives in several ways. In the worm transmission of a laser machining device, for example, coating the steel worm with BALINIT® C reduces wear of both the worm and the bronze gear.

Worm gear sets: greater loads, longer service lives

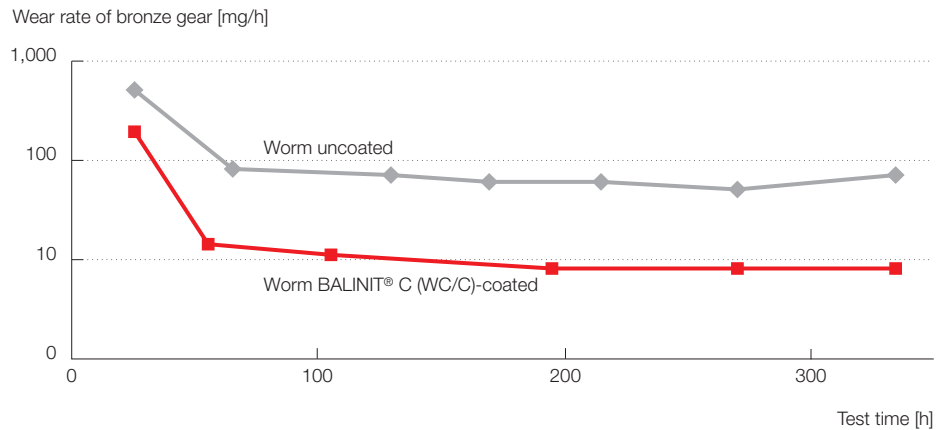

Worm set data:

Number of teeth (gear): 41
Angle: 12.5°
Shaft spacing: 100 mm

Test conditions:

Worm speed: 400 rpm

Materials:

Worm: AISI 5115 (DIN 1.7131)
Gear: Bronze, DIN 2.1060.03 (GZ-CuSn12Ni)

Worm gears with coated steel wheel

Accurate workpiece positioning in machine tools is effected with worm gears. When a classical bronze wheel is used, wear leads to errors that cannot be entirely compensated by fine adjustments; the result is dimensional errors in the work. Costly remachining is necessary particularly for expensive parts such as turbine blades. As a countermeasure, the bronze wheel is replaced with a WC/C-coated steel wheel. The coating performs two functions: It emulates the frictional qualities of the bronze and at the same time its hardness works with the supporting action of the steel to protect against wear.



Cam and follower drive system

BALINIT® C wins the comparison test by a clear margin: The values and time variation of load and velocity in cam drives imply poor lubrication conditions and a danger of excessive wear. In the search for a better solution, couples involving hardened steel, ceramic (Si_3N_4) and hardened steel with PVD coating were compared. By far the best results came about when one or both rollers were coated with BALINIT® C.

Simulation of cam drive

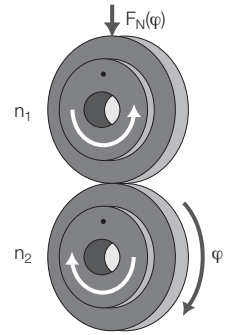
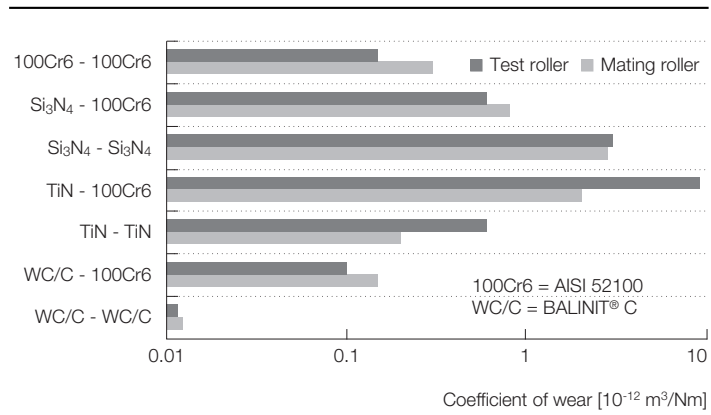

Contact force: 0-2,000 N
 Hertzian pressure: 0-1,106 MPa
 Slippage: 10 %
 Speeds: $n_2 = 200 \text{ rpm} / n_1 = 0.9 \cdot n_2$
 Source: Surface Engineering Laboratory, University of Siegen

Cam drives in can-forming machines

Very great forces must be transmitted in can-forming machines, and so cam drives are used. The low speed of motion means that no adequate lubricant film can form, and the surfaces have a tendency to scuff. WC/C coating of the rollers produced a significant increase in the service life of the cam drive.

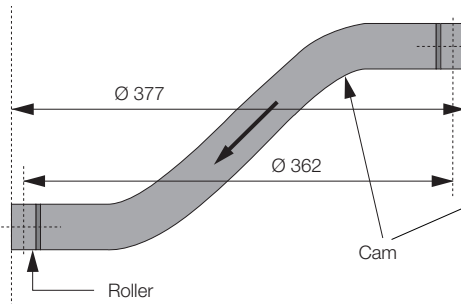

Ball screw drive system

BALINIT® C makes it possible to boost the speed of machine-tool operations. Lead screws are often used in the feed of these machines, but positioning speeds are limited by wear and friction between the balls and the return tubes. Practical tests have shown that WC/C coating of the balls in particular can reduce the frictional torque and stick-slip effects.



Ball screw drive

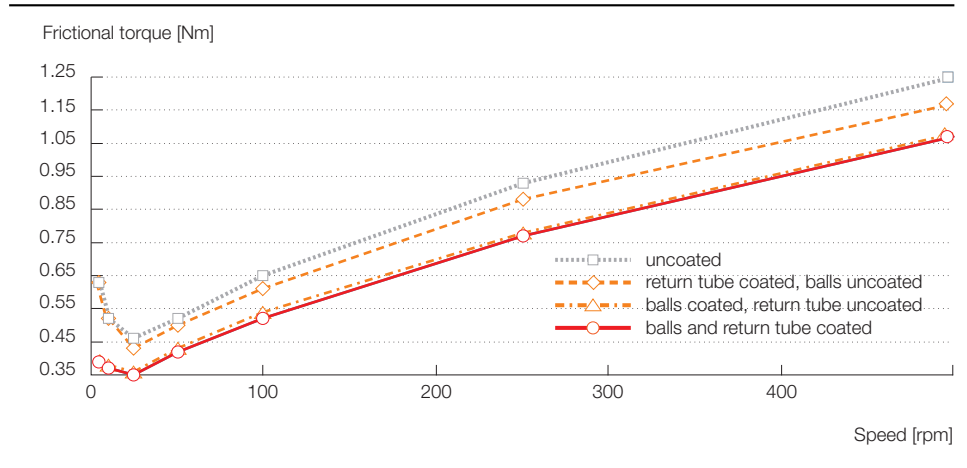

BALINIT® C (WC/C) reduces friction and wear and cuts the frictional torque of the ball screw drive. Source: WBK, Institute of Machine Tools and Production Science, University of Karlsruhe

Ball- and roller-bearings

The typical rolling motion in ball- and roller-bearings means that friction and wear conditions are generally good. When loads are severe and lubrication is poor, however, wear mechanisms can arise that will ultimately harm the entire tribosystem:

- Scuffing in case of starved lubrication
- Abrasion due to contaminants
- Surface fatigue (pitting) when overloading occurs
- Fretting and brinelling in the presence of vibration

A variety of materials are currently used in an attempt to combat these and other problems. One example is a very pure form of the standard bearing steel AISI 52100 (DIN 1.3505). Nitrided or chrome-plated steels offer protection against corrosion, while tool steels are suitable for high-temperature applications and ceramic rollers can serve in very high-speed applications.

For some applications and some frictional requirements, however, conventional materials are not adequate and special materials are too costly. BALINIT® coatings offer an excellent solution in these cases by virtue of their great hardness and dimensional stability. By affording effective protection against wear, these PVD coatings reveal new tribological potential, especially where extreme service conditions (high/low temperatures, aggressive environments, vacuum, clean-room settings) limit reliability and make lubrication difficult or impossible.

Cylindrical-roller thrust bearings

Specially designed test stands are used to study the frictional and wear behaviour of roller bearings. Critical lubrication conditions and loads leading to scuffing are preferably investigated on stands for cylindrical-roller thrust bearings. Because this type of bearing is inherently subject to high tribological stress.

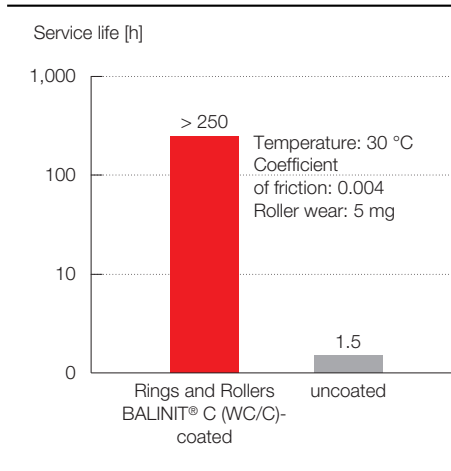

FE-8 test stand
Bearing type: 81206
Load: 33 kN
Cage material: PA 66
Speed: 15 rpm
Dry running
Source: IME, Aachen University (RWTH Aachen)



Material pairs for roller bearings

The Institute for Machine Elements and Machine Design at RWTH Aachen University studied the development of wear in thrust bearings with various combinations of WC/C coatings. In one series only the rollers were coated, in another only the rings, in another both frictional partners. Interestingly, bearings with all coated components displayed only the second-best wear behaviour, after those with coated rings.

The advantage of coating only the rings over coating the rollers is understandable because more contact area is coated and the coating itself is somewhat thicker. There is no direct way to account for the poorer behaviour with all coated components; one possible interpretation is that steel surfaces with the selected lubricant cooperate with the WC/C coating to produce especially good running-in and wear conditions. But this finding cannot necessarily be extended to

other tribosystems: It applies in the first instance only to systems with a tendency towards adhesive wear. If abrasion and surface fatigue are in question, it is better to coat both frictional partners.

Effect of material pair with coating of thrust bearing components

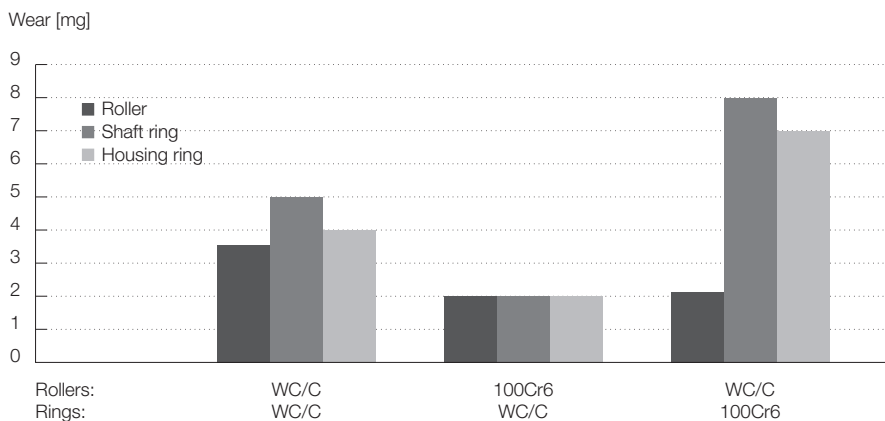

Test conditions:
Test stand: FE8 thrust bearing
Bearing: 81212
Speed: 7.5 rpm
Axial thrust: 80 kN
Contact pressure: 2,000 MPa
Bearing temperature: 70 °C
Running time: 80 h
Base material: AISI 52100 / DIN 1.3505
Source: J. Loos, RWTH Aachen

Partial coating of rollers

Another interesting experiment involved coating various numbers of the rollers but not all of them. The aim was to show whether and how well coating protects against wear even when not all the rollers are coated. Surprisingly, even a few coated rollers bring about marked improvements. Coating just two of a maximum of 15 rollers cuts

wear by some 50 %, and treating half the rollers results in more than a 90 % decrease in wear. This behaviour occurs because the coated rollers promote good running-in and burnishing even for the rings, which also receive some of the coating material. The same phenomenon can also be observed in respect of the uncoated rollers.

Wear behaviour with various numbers of rollers coated

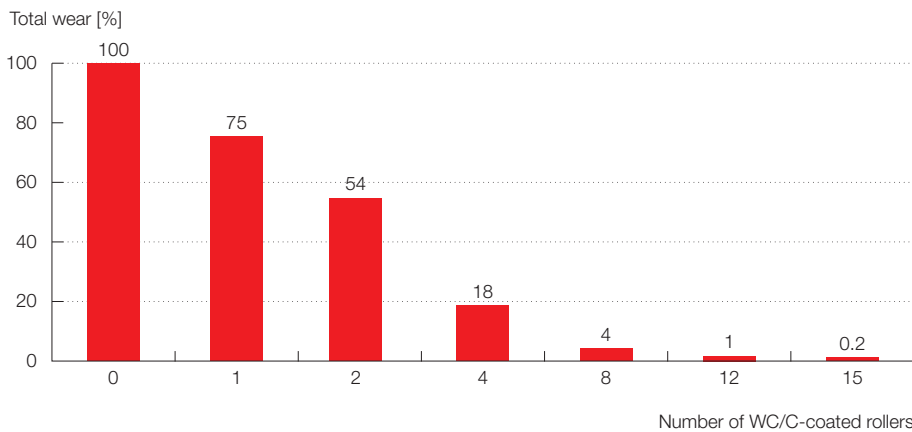

Test conditions:
 Test stand: FE8 thrust bearing
 Bearing: 81212
 Speed: 7.5 rpm
 Axial thrust: 80 kN
 Contact pressure: 2,000 MPa
 Bearing temperature: 70 °C
 Running time: 80 h
 Base material: AISI 52100 / DIN 1.3505
 Source: J. Loos, RWTH Aachen

Surface fatigue

Early in the 1980s tests on spindle bearings showed that a reduction in race wear can be expected with WC/C coating. More recent measurements have been carried out to examine in detail the actions of the individual components. Test-stand trials on radial bearings have shown for example that applying a WC/C coating to the inner rings yields only a slight extension of service life because now the uncoated rollers begin to wear. Only when the rings and the rollers are coated does a significant increase in life come about.

Race wear in high-speed spindle bearings

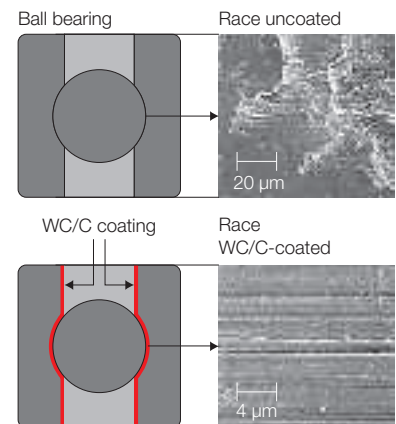

Bearing type: 7014 P4 spindle bearing
 Test duration: 50 h
 Speed: 19,000 rpm
 Speed coefficient: $1.7 \cdot 10^8$
 Lubricant: Grease

Ball bearings

BALINIT® C effectively protects ball bearings against tribo-oxidation and brinelling under severe static-vibrating loads. Electroplated chrome and Teflon® (PTFE) coatings had little effect against these forms of wear. The WC/C coating reduces wear and noise, and bearings in such settings as electrical-discharge machining (EDM) equipment showed a more than doubled service life.

Ball bearings under vibrating load

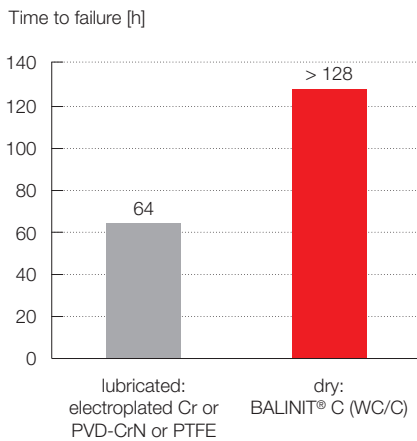

Wear reduction with BALINIT® C (WC/C)-coated roller bearings in EDM machines.
Source: INA/Balzars

Bearing balls

BALINIT® C is applied not only to inner and outer races and cylinders but also to the balls in ball bearings. The typical coating thickness is 0.5-1 µm with a uniformity in the order of ± 0.1 µm measured over the full circumference. The slight increase in roughness is offset by the good burnishing qualities of the coating.



Linear guides for semiconductor component assembly

Lubrication is not acceptable in some industries. In semiconductor manufacturing, for example, machinery must operate without lubrication on grounds of cleanliness. Drive components must none the less operate reliably over long service lives. This goal is achieved in linear guides by applying a WC/C coating to the rollers. WC/C-coated rails with uncoated steel rollers display markedly longer life than uncoated rails with ceramic rollers.

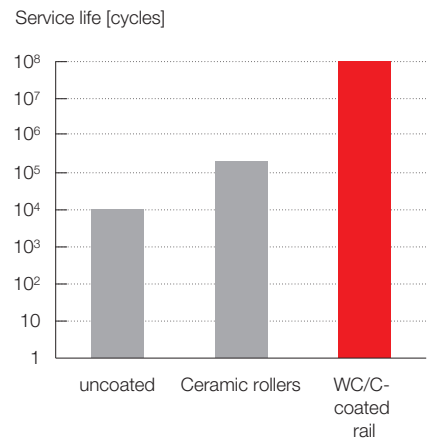

Load: 20 % of dynamic load coefficient C
Dry
Source: Schneeberger / Roggwil

Fluid technology

The Montreal Protocol requires that, after 2020 chlorofluorocarbons (CFCs) are no longer used in automotive and home air conditioners, compressors and refrigerators. New concepts based on environmentally benign refrigerants, however, generally involve poorer lubrication and wear properties.

Makers of hydraulic drives are also more and more confronted with lubri-

cation and corrosion issues. The trend toward lighter weights and higher pressures and speeds means that hydraulic system components must be able to handle more-severe tribological stresses. In fields where water is used as the pressure medium instead of oil, or where hydraulic components are exposed to more-drastic corrosive and abrasive operating conditions, there are even more requirements that must be met.

Hard coatings have been proposed as a way of addressing these problems. BALINIT®-coated components experience much less wear and thus extend the life of coolant and air compressors, hydraulic pumps, and hydraulic and pneumatic valves and fittings. What is more, coating makes it possible to phase out costly materials such as bronze, carbide and ceramic.

Compressors

CFCs used as coolants in compressors mix well with lubricants and generally permit the operation of compressors without wear and other causes of upsets. In contrast, environmentally benign CFC-free refrigerants are poorly miscible with lubricants, so that refrigerant and oil phases separate. Lubrication is often inadequate as a result, and mechanical components cannot be protected against wear over the requisite service life.

Air compressors operated without lubricant are subject to similar requirements, with corrosion even more of a problem because of humid service environments.

Manufacturers of air and refrigerant compressors are increasingly taking advantage of PVD coatings, which permit reliable compressor operation.

Vane compressors

Operation with CFC-free refrigerants entails deficient lubrication resulting in severe wear. Coating the steel vanes with BALINIT® CNI or BALINIT® C markedly reduces wear of the compressor vanes and rings.

Even non-chlorinated hydrocarbons must be regarded as problematical with an eye to the future. While these

substances do not harm the ozone layer, they do contribute to the greenhouse effect. Carbon dioxide (CO₂), on the other hand, is a very environmentally safe coolant. It is being tested for use in vane and piston compressors for household appliances and vehicles. In both systems, CrN and WC/C coatings combined with glycol and ester-based lubricants yield very good frictional and wear behaviour.

Vane compressors with CFC-free refrigerants

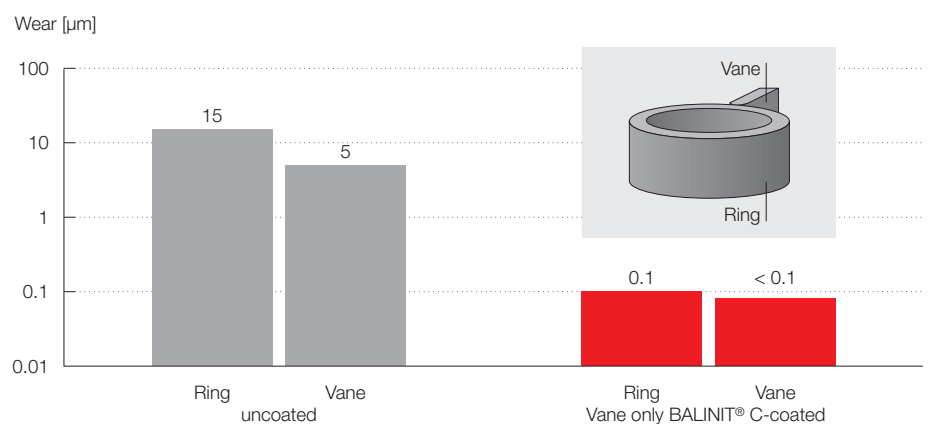

Test conditions
Duration: 1,000 h
Pressure: 3.5 N/mm²
Temperature: 100 °C
Refrigerant: CFC-free
Ring material: Cast iron
Vane material: Steel

Screw compressors

Conventional screw-type air compressors are designed for synchronised dry running or unsynchronised operation with oil injection. Where safety or environmental considerations rule out oil injection, complicated designs with synchronising gears have had to be used. Tests with BALINIT®-coated rotors have shown that unsynchronised equipment can function reliably if water injection is used in place of oil. Scuffing occurs in a very short time without the coating. While chromium nitride (CrN) improves the wear behaviour, 1,000 hours' operation wears away 60 % of the CrN-coated surfaces. With BALINIT® C, no further surface wear can be detected after 3 % running-in wear.

Screw compressors with water injection

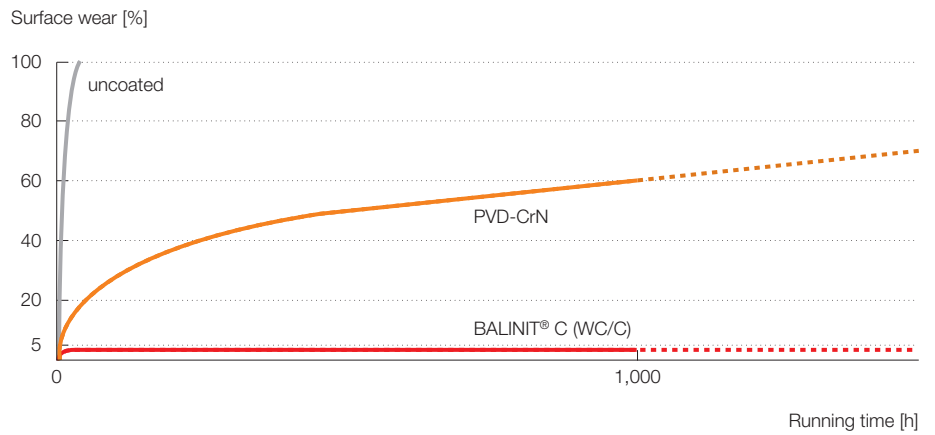

Test conditions:
Both rotors coated
Sliding speed: 50 m/s
Test duration: 1,000 h
Cooling and lubrication with water
Unsynchronised
Source: University of Dortmund



Hydraulic pumps and hydraulic motors

High pressure, extreme flow velocities and the presence of fine particles stress water-pump components, often to the point that carbide is no longer an adequate material solution. The exceptionally hard BALINIT® DLC and BALINIT® FUTURA NANO coatings offer good wear protection, thereby opening up further scope for design innovations.

Other severely stressed hydraulic components are also protected against such wear mechanisms as erosion, cavitation, deformation, adhesion and abrasion when BALINIT® coatings are applied.

The qualities of hard coatings also make them suitable for special applications. For example in mining (danger of fire) or forestry (environmental pollution) mineral oils cannot be employed as pressure media. Low flammable water-based hydraulic media (HFA, HFC) are used in these fields. BALINIT® coatings can meet the tribological challenges (e.g. insufficient lubrication) in all such cases.

Radial-piston pumps Radial-piston motors

High power density in very compact hydraulic motors makes lubrication difficult, so that frictional losses and adhesive wear occur. BALINIT® C cuts static friction between the rollers and the grey-iron pistons by 40 %; energy losses on motor starting are lowered by 18 %; and stick-slip processes do not occur. Furthermore, WC/C coating prevents scuffing and improves the performance of bearing rollers so much that virtually no wear can be detected after 58,000 revolutions. In contrast, an uncoated steel roller displays as much as 10 µm of wear.



Radial-piston hydraulic motor

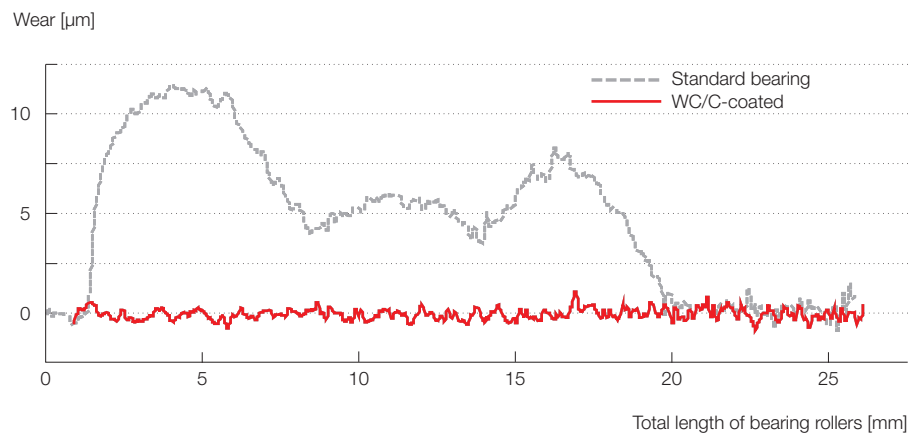

Wear reduction with WC/C coating of roller bearings in the radial-piston motor

Load: 70 kN

Temperature: 50 °C

Test duration: 58,000 revolutions

Speed: 6 rpm

Lubricant: Shell Tellus 68 S / 4 mg/l ISO MTD

Source: U. Olofsson, H. Sjöström, U. Sjödin / ASME Journal of Tribology

Axial piston pumps

Making the sliding-shoe components from BALINIT® C-coated steel instead of bronze improves durability in axial piston pumps. The system becomes more resistant to abrasion, mechanical overload and deformations that typically affect bronze shoes as a result of rising pressures and speeds. The coating safeguards the sliding function and increases wear protection, while the steel prevents deformations. BALINIT® C also improves the frictional behaviour of the axial pistons, thus preventing scuffing damage that results from starved lubrication.



Bronze: abrasive wear and deformation



Steel and BALINIT® C (WC/C): wear < 1 µm

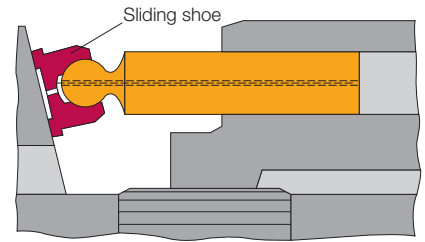

Test conditions:

Max. pressure: 350 bar

Max. speed: 2,200 rpm

Test duration: 1,000 hours

Abrasion properties of hydraulic system materials

A pairing of hard and soft materials of construction is often used to minimise wear in axial piston pumps; an example is nitrided steel against bronze for the cylinder drum and valve plate. The

optimal combination was determined by model measurements of the wear behaviour of various materials, including PVD-coated components. Solid particles in the flowing medium cause a measurable increase in the clearance between the discs under test. Marked

improvements come about if soft sliding materials are replaced by a heat-treatable steel (AISI 1045/DIN 1.1191) and the hard plate is given a PVD coating at the same time. The entire system gains in abrasion resistance.

Abrasive behaviour of materials for hydraulic components

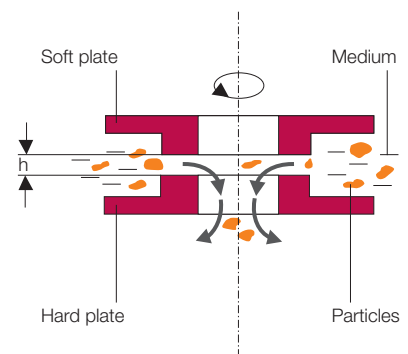
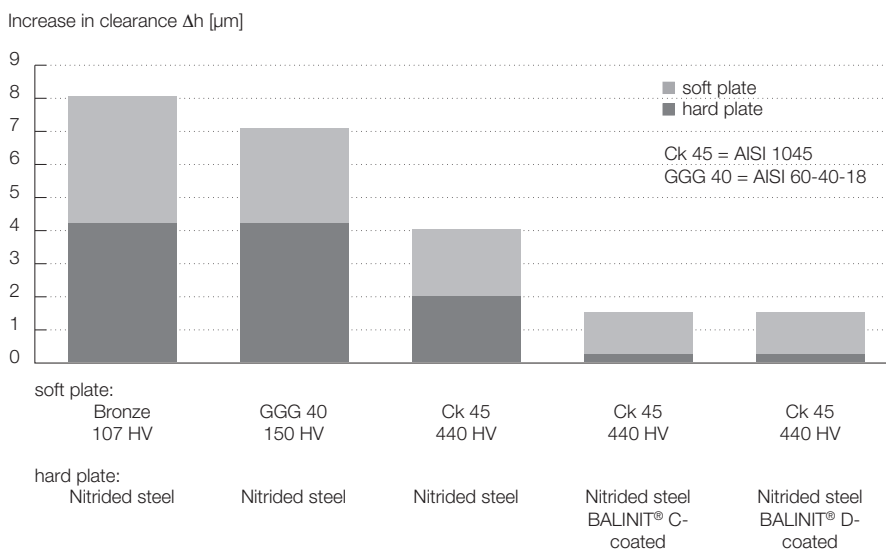

Three-body wear:

Particle concentration: 2.5 g/l

Particle size: 0-50 µm

Original clearance h: 32 µm

Medium: HFA oil-water emulsion

Source: PhD Thesis, St. Lehner,

Institute for Fluid Power Drives and Controls,

Aachen University (IFAS, RWTH Aachen)

Vane pumps with additive-free oil

Uncoated vanes in a vane pump tested with additive-free hydraulic oil scuff after just a few minutes. In practice, vanes coated with BALINIT® C show a markedly longer service life than uncoated vanes and those coated with titanium nitride (TiN).

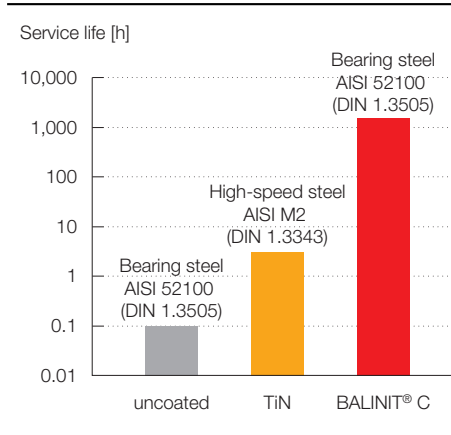

BALINIT® C (WC/C)-coated vanes extend pump service life, especially when hydraulic media with little wear-protection power are employed.
Hydraulic medium: Additive-free mineral oil

Screw pumps in water service

BALINIT® C prevents seizure in small screw pumps operated in fresh water or in maritime applications. The screw spindles are made of corrosion-resistant steels with a slight tendency toward abrasive wear. The WC/C coating, which is inert to attack by water, prevents such wear and improves service life.

Abrasion-resistant high-pressure pump pistons

Even where carbide (Vickers hardness 1,500) is used in high-pressure pumps, grooves can develop and give rise to leakage. The BALINIT® DLC carbon coating, with its high Knoop hardness (over 2,000), improves the abrasion resistance. Expensive materials such as carbide or ceramic pistons can thus be replaced by hardened steel provided surface pressures are not too high.

Internal gear pumps

Components (such as the gear shaft and gear ring) of internal gear pumps handling abrasive media are subject to such severe wear that unacceptable delivery losses occur. A hard, extra-thick (approx. 7 µm) TiAlN coating greatly reduces wear and thus loss of capacity.

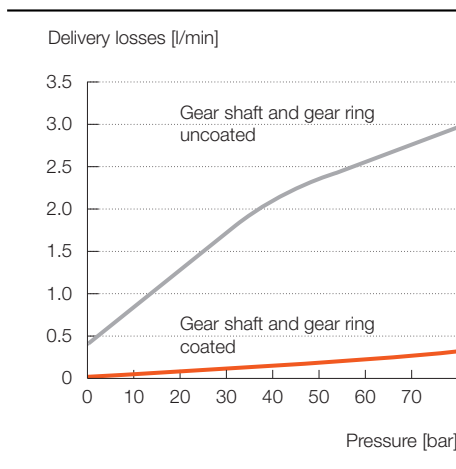

Valves and fittings

Valves and fittings often suffer corrosion coupled with abrasion and erosion by suspended particles. Abrasion resistance and protection against scuffing and corrosion are essential requirements in the fabrication of components for high-pressure systems in particular.

Solution concepts that unite all these properties, however, are virtually impossible to implement with classical material pairings and without the use of coatings.

Leakage protection for hydraulic valves

PVD carbon coatings such as BALINIT® C guard valves against wear and thus allow them to operate precisely and efficiently without leakage. By virtue of their great hardness, these coatings protect the precision geometries

of housings, seats and plunger edges even when contaminated media are present. The net effect is to prevent leakage. In a trial with proportional directional control valves and a HFA hydraulic fluid, wear was cut to a fraction of that measured on an uncoated valve of heat-treatable steel.

Wear behaviour of BALINIT® C (WC/C)-coated hydraulic valves

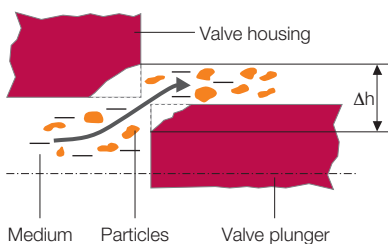
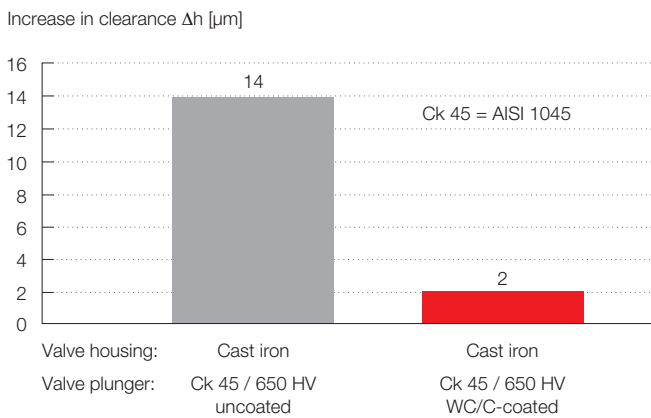

Flow rate: 50 l/min
 Valve type: 4/3 proportional control valve
 Medium: HFA oil-water emulsion
 Source: PhD Thesis, St. Lehner,
 Institute for Fluid Power Drives and Controls,
 Aachen University (IFAS, RWTH Aachen)



Dry operation of pneumatic valves

BALINIT® C lowers outage costs by making it possible for pneumatic valves to operate without lubricant. These valves perform functions such as precisely controlling the motion of paper webs in papermaking machines. They are usually lubricated with grease, but they seize up, causing an expensive production stoppage, if the lubrication is lost. Coating with WC/C reduces friction to the point that the pneumatic valves can function without any grease at all.

Valves in air conditioning systems

Corrosion and tribo-oxidation threaten the stems of the valves that control the admission of outside air in climate-control systems. Applying BALINIT® C and BALINIT® DLC coatings cuts the coefficient of friction and distinctly improves corrosion protection, so that the valves can perform their precise control function far longer.



Other applications

Machinery and systems where long life and/or reliability is needed impose extreme requirements on precision components, with an increasing risk of failure. Coating with BALINIT® can significantly boost the performance, reliability and service life of mechanical components so that they can meet all such specifications.

Many areas of mechanical engineering benefit from the performance-enhancing qualities of coatings. Functional reliability is improved, maintenance intervals lengthened and operating costs lowered.

Several BALINIT® coatings are approved for food industry and medtech applications by RCC (Registration and Consulting Company) and FDA (Food and Drug Administration).

Machine tools

Machine tools have to produce ever more quickly and precisely. The consequences include greater stresses and hence more wear, which works against machining precision and product quality. BALINIT® coatings contribute to maintaining precision as well as providing custom-tailored wear protection for machine-tool components such as gearboxes, clamping systems, lead screws, guide rails and disc cams.

Clamping systems

BALINIT® C and BALINIT® DLC keep clamping systems working at a high level of precision. Collet chucks suffer undesired and precision-impairing wear, particularly where clamping operations are fast, as in mass production, or clamping forces are high. Coating with BALINIT® C and BALINIT® DLC cuts down on tribo-oxidation and fretting and thus improves the efficiency of clamping systems.



Injection moulding machines

Sliding elements such as ejectors, gates and cores in injection moulding machines are effectively protected against wear and scuffing by BALINIT® C. The coating is a must when the end product is not permitted to come into contact with lubricants and mouldrelease agents as they contaminate it. By virtue of its anti-adhesion properties, BALINIT® also reduces the

adhesion of molten stock to screw tips, backflow valves, nozzles and shutoff needles.

Threaded cores

Lubricants and mould-release agents must not be employed in the injection moulding of caps for pharmaceutical packagings. With BALINIT®-coated cores, the maintenance interval for a 30-cavity mould can be extended from one week to over eight months. Reliable demoulding and a 10 % shorter cycle time result in a 20 % gain in productivity.



Ejectors for plastics moulds

BALINIT® C (WC/C) prevents seizing of ejectors, improving reliability in the injection moulding.



Textile machinery

Components of textile machines experience severe abrasive wear from fibres and additives (e.g., titanium oxide) as well as contaminants (dust). What is more, increasingly fast motions in the machines imply high sliding speeds in metallic frictional contacts.

Weaving machinery

Weft yarn holders

Borided steel has been used for weft yarn holders in gripper looms. However, the surface treatment produces a relatively rough surface resulting in poor performance. Coating with BALINIT® CNI combines high hardness (thus wear resistance) with surface smoothness, so that the yarns can be reliably held.



The most highly stressed reeds in weaving looms are coated with TiN, CrN and DLC. DLC coatings are employed in texturing machines. TiN, CrN or DLC coatings are applied to nozzles in air-jet looms.

Spinning machines

CrN coatings have proven their worth on opening cylinders of open-end spinning machines as well as on rings of ring spinning frames.

Carbon coatings in ring spinning frames fail prematurely because of the too high temperatures produced by the extremely high speed of the ring travelers.

CrN and DLC coatings are applied to steel and ceramic thread guides.



Opening cylinder of an open-end spinning frame with BALINIT® CNI coating



Spinning ring with BALINIT® CNI coating



Thread guides with BALINIT® DLC coating

Food processing machinery

Corrosion in food processing machinery is often combatted with austenitic stainless steels. However, because these are relatively soft materials, wear and scuffing are major problems. Additional problems arise, for example, when filling plungers run in a closely toleranced cavity, the product exerts only a slight lubricating action, and may contain powdered additives that increase wear. In many cases lubricants and conventional coatings cannot be considered because all materials that come into contact with foodstuffs have to be inert to them. BALINIT® coatings meet these requirements and are FDA approved.

Metering plungers

Coating with BALINIT® CNI greatly improves the functioning of metering plungers used to fill marmalade jars. Corrosion results both from the escape of fruit acid and from condensation when the equipment is not operating. Also abrasive wear occurs at gaskets due to deposits of marmalade. With BALINIT® CNI coating, filling stations can run without maintenance for many months.



Medical technology

Cleanliness and lubricant-free operation are essential for the use of medical apparatus, but these conditions make surgical instruments susceptible to wear. The BALINIT® C and BALINIT® DLC carbon coatings have proved advantageous in many respects. They prevent scuffing and ensure proper functioning even under dry conditions, as in pneumatic components of devices for the implantation and extraction of bone-marrow needles or in surgical bone saws. At the same time, they safeguard components and devices against corrosion during sterilisation.



The gold-yellow colour of BALINIT® A (TiN) serves to distinguish coated from uncoated instruments for ophthalmic surgery. What is more, the coating is valued for its aesthetic effects.



Precision mechanics

Coatings are used in precision mechanics to reduce friction and wear and also for decorative purposes. For example, sliding guides for microscopes and sliding case elements for mobile telephones are coated with WC/C.

Components for mechanical watches (pinions, shafts, bearings, springs, spring housings) are coated with BALINIT® C and BALINIT® DLC in order to lengthen service intervals and permit oil-free operation. In addition, carbon and nitride coatings are applied to lend an attractive colour and appearance to these articles. Elements made of steel, nickel-plated brass and silicon are coated.

Partners in your success

Since the BALINIT® rollout in 1980, Balzers PVD technology has been used to coat many hundreds of millions of components for renowned automotive manufacturers and their suppliers as well as for the mechanical engineering industry. The processes have found use in both low and high volume production. Balzers has gained a position of world leadership in the field, pursuing a strategy that begins with research and development and culminates in a high standard of quality implemented in a global network of coating and application centres.

This strategy meets the requirements that govern a successful component coating business today:

- Focus on custom coating solutions
- Efficient manufacturing structure and customer-oriented project management
- Integration of specific know-how on typical tribosystems leading to a flair for picking the right coating and process

In this way Balzers can achieve the goal it has set itself: to be a partner and advisor in development, with competence in not just coatings but also components and systems.

Research and development

The solid know-how that Balzers has acquired in coating processes is based on our world-wide business experience and our close contacts with industry as well as many industrial engineering and design institutions.

Development of coatings, applications and equipment

In the Balzers R&D centre at the Liechtenstein headquarters, laboratory staff carry out applications studies for customers and do basic research on PVD and PACVD processes that hold promise for mass production. New coatings are tested at loads far greater than those met with in component service in order to push the envelope of coating performance and systematically eliminate defects. The BALINIT® product family and the range of coating solutions are thus more and more optimised in terms of desired product specifications. Plant and manufacturing techniques are also in steady development, as are technical quality systems for production. The development of new coatings is carried on at manufacturing plants in order to ensure a rapid transfer to mass production.

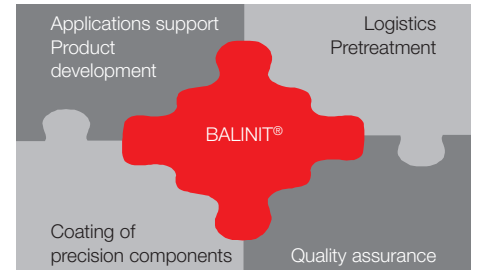

Balzers expertise and services: competence for component and system

Analysis and quality assurance

Along with standardised quality assurance methods, Balzers can provide detailed services such as tribological problem work-ups and metallographic examinations and assessments. Advanced measurement techniques for coatings in the order of 1 µm thick are also offered.

Partnership for development

Balzers works with independent laboratories and research institutes for especially difficult tasks calling for highly specialised test methods. What is more, in an effort to continuously improve its coatings, Balzers cooperates closely with respected practitioners of special measurement techniques in order to develop metrological systems for quality assurance and testing of coated components.

Test methods for quality assurance

Reliable methods of measurement (standard test conditions, reference substrates, ambient conditions) are essential if the properties of PVD and PACVD coatings are to be determined and assessed. Judging the quality of a coated component that has been mass produced requires making a binding statement regarding the specifications submitted by the customer.

To this end, Balzers employs methods that comply with VDI (German Engineering Society) Guidelines 3824 (Sheet 4) and 3198.

Test methods for quality assurance

Method	Attribute	Constraints	Precision	Destructive for Coating	Destructive for Substrate
Spherical abrasion	Coating thickness	Geometry Roughness	0.3 - 0.5 μm	yes	yes
X-ray fluorescence (XRF)	Coating thickness	Geometry Composition (element)	0.3 - 0.5 μm	no	no
FTIR Infrared spectroscopy	Coating thickness	DLC-coating > 0.5 μm	0.1 μm	no	no
Rockwell hardness (HRC)	Substrate hardness	Substrate hardness Geometry	± 1 HRC	yes	yes
Rockwell test	Coating adhesion	Substrate hardness Geometry	± 0.5 HF-Class	yes	yes
Stylus profilometer	Roughness	Geometry	*	no	no

* Function of test conditions

Determination of coating thickness by calo grinding

In this method, a spherical cup is ground with a steel ball. The spherical calotte is measured and the coating thickness is calculated.

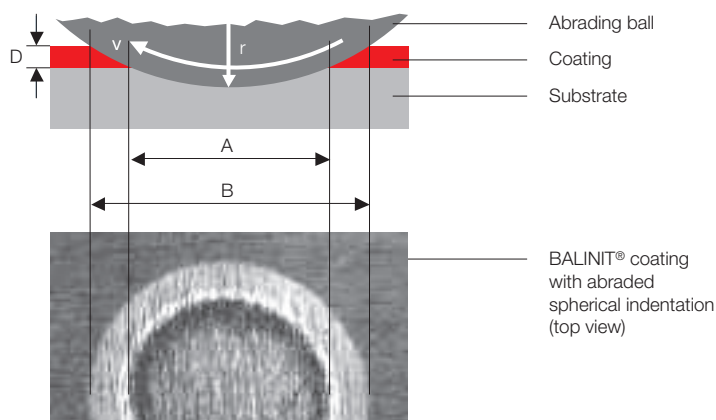

Spherical abrasion test:
The coating thickness D is calculated from the measurements A and B and the ball radius r .

Coating thickness measurement by x-ray fluorescence (XRF)

Coating thickness is measured by irradiating the surface under test with broad-band x-rays. The intensities of those x-ray fluorescence lines, which are characteristic of the coating, are used as a measure of coating thickness. Calibrated spectra for the coating and substrate materials under study are stored in the instrument. The substrate and coating material of a specimen must be known; the corresponding values are input as refer-

ences before the measurement is performed. The instrument then computes the coating thickness from the observed intensities for the coating and substrate material.

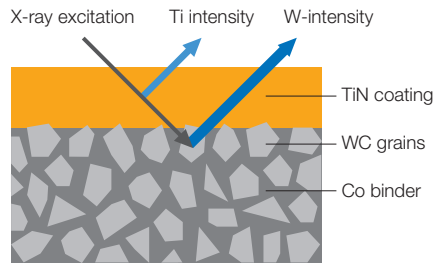

Coating thickness measurement by infrared spectroscopy

A special infrared (IR) procedure has been devised for BALINIT® DLC. Infrared light directed at the IR-transparent DLC coating is partly transmitted and partly reflected; the coating thickness is determined from the interference effect.

Adhesion test by Rockwell method

A conventional Rockwell hardness test (DIN 50103) is performed, and then the network of cracks and coating flakings at the periphery of the indentation is examined under the optical microscope. The adhesion is rated in six adhesion classes as set forth in VDI Guideline 3198.

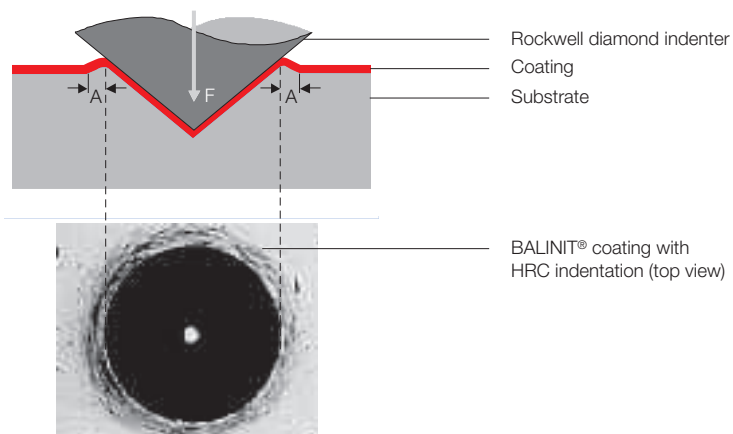

Use of Rockwell indentation to measure adhesion: Coating adhesion is determined by comparing the damage in region A of the Rockwell indentation to a series of standard images.

Stylus profilometer

Many critical precision parts today are manufactured to micrometer tolerances and must display the specified geometry after coating as well. Characteristics such as diameter, planarity and concentricity therefore have to be tested and documented after coating.

Visual inspection with the optical microscope

Surface defects can have a detrimental effect on the tribological properties. Visual inspection to assess surface quality is performed with the optical microscope or illuminated magnifier; in large-scale production, totally automated camera systems are employed. Standardised defect catalogues used as references describe the typical features of ground and coated parts.

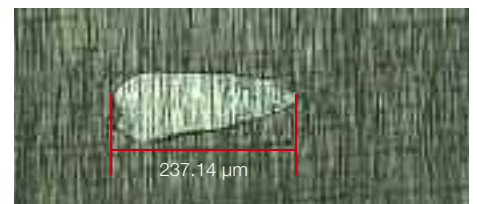
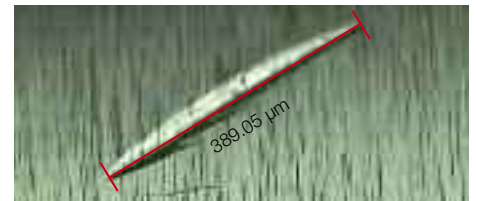

Methods used for specification and analysis

Method	Attribute	Prerequisites	Precision	Destructive for Coating	Destructive for Substrate
Cross section grinding/fracture SEM, microscope	Coating thickness Coating structure	none	0.1 - 0.5 µm	yes	yes
EDX / SEM Energy-dispersive X-ray spectroscopy	Coating composition	Detectable element: boron or higher	*	no	no
Nano-/microhardness	Coating hardness	Geometry, roughness, coating thickness > 1µm	± 20 %	yes	no
Scratch test	Coating adhesion	Substrate hardness Geometry	*	yes	yes
Calowear test	Coefficient of wear	Planar surface Roughness	*	yes	no
Tribometer Rotation, Oscillation	Coefficient of friction Lifetime test	Geometry	*	yes	yes
Surface scanner	Surface topography	Geometry	*	no	no
Coating structure	Depth profile analysis	Geometry	± 2 %	yes	yes
XRD structure analysis	Crystal structure	Geometry	*	yes	yes

* Function of test conditions

While the methods used in the factory support economical, standardised quality assurance in mass production, more profound analytical methods are available for development purposes. Some of these, however, are quite expensive and therefore do not often find use in quality assurance.

Balzers employs the following instruments:

Scanning electron microscopes (SEM) with EDX

These microscopes yield high-resolution images of the surface. They use EDX (energy-dispersive x-ray spectroscopy) systems to analyse the coating composition and identify the elements present. The SEM is also used to analyse the wear mechanism at work in a tribosystem. The photomicrograph at right shows fatigue wear on a critically stressed valve-train component coated with DLC.

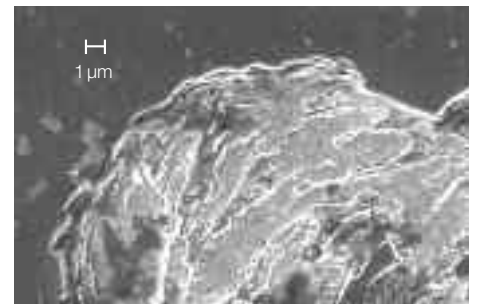

Coating fatigue in a severely loaded DLC-coated valve-train component.
Scanning electron micrograph, 8,000x

Scratch test

A Rockwell C diamond is drawn over the coated surface under an increasing load. The coating adhesion is assessed by examination under the optical microscope to determine the nature and extent of coating damage versus load.

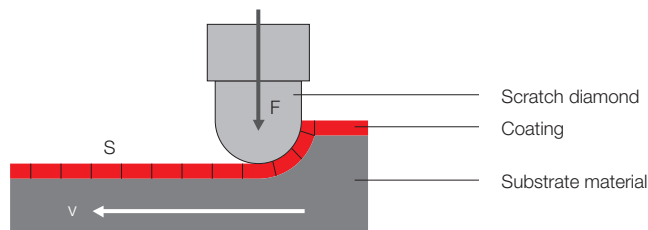

Scratch in BALINIT®-coated surface, top view

Abrasive wear test (Calowear)

The coating is abraded with a steel ball and an abrasive paste, and its coefficient of wear is determined from the results. In contrast to the case of thickness measurement, the grinding proceeds only partway into the coat-

ing, not right through. The test involves standardised parameters such as configuration, sphere size, speed and diamond slurry. The wear volume is then compared with a reference material, most commonly a standard DLC coating.

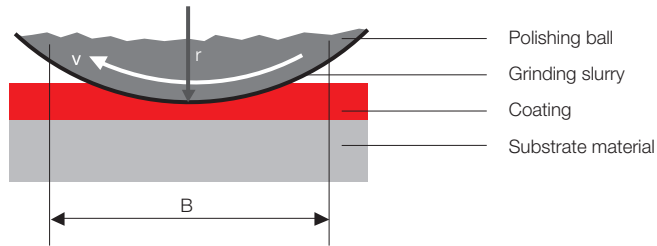

Tribometer

The tribometer is used to measure the coefficient of friction μ or the wear behaviour of surfaces. The specimens for test can be set in rotation or oscillation during the measurement, and lubricant may be added depending on the purpose of the measurement.

Tribometer with oscillating motion

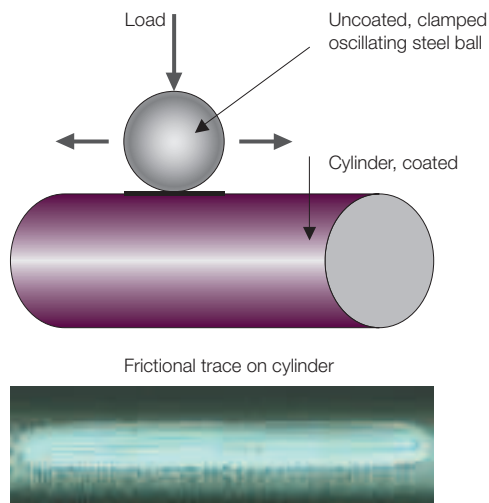

Tribometer for sliding wear test

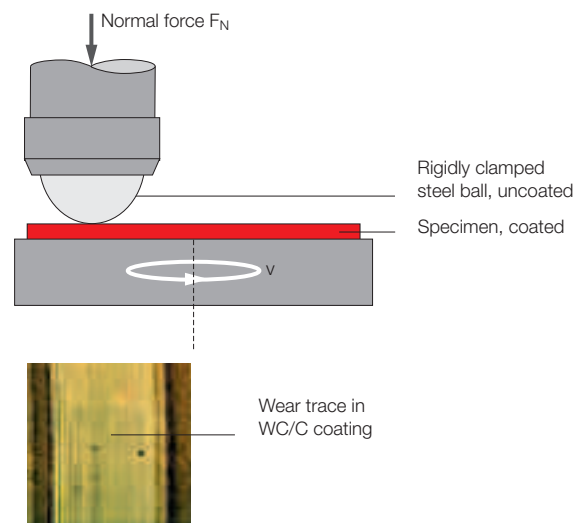

Surface scanner

This laser scanner operates without touching the specimen and produces a three-dimensional scan record used to verify the quality and roughness of coated component surfaces.

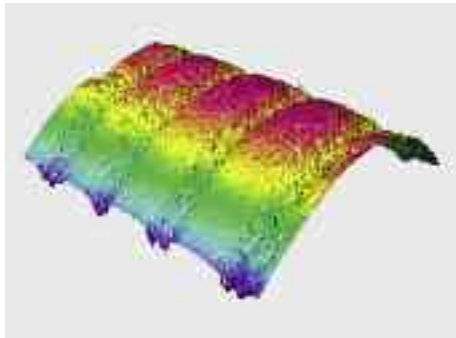

Structure analysis by x-ray diffraction

XRD analysis uses x-ray diffraction to identify the crystalline phases of hard coatings. The instrument holds all possible phases of such coatings in memory and compares them with the specimen.

Nanohardness and microhardness

Because of the relatively large test loads used in the classical Vickers and Knoop methods of hardness measurement, all that is determined is the plastic deformation of the indentations. The diamond used to measure thin films must not penetrate to more than 10 % of the coating thickness. Very light test loads (10-50 mN) are needed as a consequence. Given the shallowness of penetration, the elastic deformation contribution must also be taken into account, and so dynamic methods are employed. Loading and unloading curves are recorded for use in determining the coating hardness; the results are then converted to conventional Knoop and Vickers hardnesses. Simple Knoop measurements are performed on the less-elastic nitride coatings, but dynamic penetration measurements are essential for highly elastic DLC coatings.

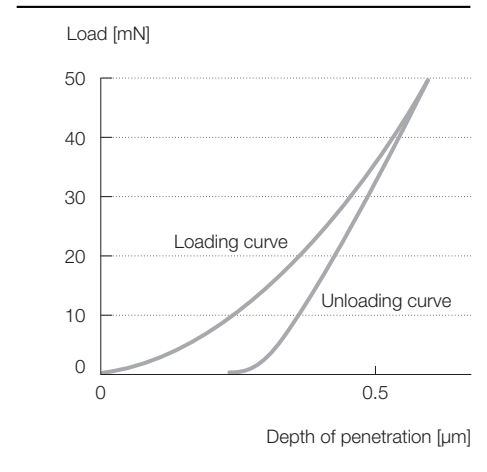
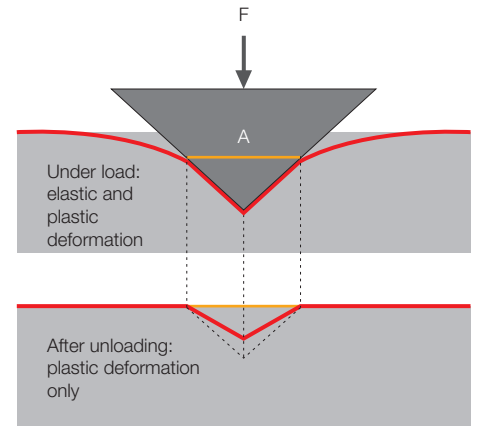

Applications support

Balzers places worldwide applications support at your fingertips:

Tribology and materials consulting

Years of research and experience with PVD coating processes point to tribological solution concepts that can minimise wear and friction in a wide range of applications.

Early collaboration in product development

One way of fully realising the technical and economic potential of coatings at a reasonable cost in time and money is to involve a team of specialists - surface engineers, manufacturing engineers, tribologists and designers - at an early point in the development of components that will be coated. Balzers can serve as a design partner, casting an expert eye on the system, bringing its long experience to bear on high volume production, and offering advice on component design for coating.

Convenient applications support centres

A global network of applications support centres enables customers to get quick service on-site and gives them early access to Balzers' technological innovations. Balzers has representatives in all major industrial regions of Europe, the Americas and Asia. Every site provides the same consistently high standard of quality in all areas of competence, procedures and technical capabilities. The development of novel, one-off coating solutions is the most intensive form of applications support for Balzers customers.



Custom services

Balzers has made it a goal to put total technological competence behind the services it offers throughout the value-creation chain of production techniques and processes. Coating equipment and processes are devised and improved at Balzers and their use is oriented to minimising costs. Contributing factors include:

- Flexible employment and optimal utilisation of plant capacity with modular coating systems
- Short turnaround times
- Minimal use of consumables
- Integration of PVD coating equipment into automated production
- Upgrading of automated production cycles in collaboration with customers with the aim of improving quality and productivity

Depending on customer requirements regarding technology, flexibility and readiness to invest, Balzers along with its coating service offers access to a number of PVD business models.

Customer-oriented products and services

Sales of equipment and production lines

When a customer wants to integrate coating into the production process and take responsibility for this function, Balzers sells single systems or turn-key production lines. Here the customer acquires a well-defined coating process with an assurance of equipment functioning and coating quality. What is more, Balzers offers support, whether in the form of staff training and qualification, service agreements, or retrofits to equipment and processes.

Job coating

From incoming inspection of components to coating and reshipping, Balzers offers the entire production process on a job basis. This means big cost and quality advantages for the customer, as well as savings on know-how acquisition, staff training and practical operations. The global network of Balzers coating centres is continually expanding. Because production cycles in the centres are closely tied to delivery deadlines, Balzers also offers comprehensive logistics that can be integrated seamlessly into customer process chains and adapted to the needs of the industry.

In-house coating

For high volume production, Balzers can locate where the customer chooses, thus providing short routes and long-term advantages. This means that Balzers performs component coating on site in a way that can be integrated into the customer's production cycles. Furthermore, Balzers takes full responsibility for this service.



World-wide coating service

All the centres employ the same equipment and the same know-how. The setup guarantees a high, reproducible standard of quality (ISO 9001, ISO/TS 16949).

Production process and process engineering

The path that leads from incoming inspection of precision components for coating to shipment back to the customer is a specialised production process. Its many steps can be tailored to the coating that is required and its special qualities.



Incoming inspection

The components for coating are checked to verify number of pieces, material and surface condition. The steps in carrying out the job are then determined on the basis of the customer's specifications.

Cleaning

This step involves several treatments in an ultrasonic cleaning line using aqueous alkaline solvents with no polluting additives.

Clean surfaces are essential for coating adhesion, so Balzers lays great stress on surface preparation for PVD coating. The last steps in treatment and conservation preceding application of the coating are defined in consultation with the customer and adapted as necessary to the requirements of PVD coating.

The cleaning of components for high volume production is simplified by shipment in special baskets and by automatic loading of the cleaning line.

Pretreatment

If further treatments are needed, Balzers employs appropriate technologies. Heating in vacuum furnaces, for example, serves to remove material residues from tight holes, while micro-blasting takes off porous surface layers.

Loading a batch

Before coating, the components are loaded on an interchangeable turntable and placed in the coating system. This operation is mostly automated in the case of high volume production. The customized configuration and fixturing of the components ensures reproducible precision.

Coating

The coating step consists of a series of automatically controlled and documented processes. The special Balzers coating technology involves the following operations:

- Pump-down of the coating system to a base pressure of around 10^{-6} mbar
- Equipment and safety check
- Heating of components to the proper temperature
- Ion etching to get atomically clean component surfaces
- Coating by a PVD/PACVD process
- Cooling down
- Equipment check and process check

Balzers' coating know-how becomes apparent at the transition from the etching to the coating phase. Optimal adhesion of the functional coating is ensured by precisely controlled application of suitable intermediate films by monolayer or multilayer processes. Control of the plasma parameters determines the coating properties, while the tested hardware provides the needed process reliability.



Final inspection

The last stage of inspection involves checking properties such as hardness, coating thickness and adhesion and performing a visual examination. In high volume production, an agreed number of test pieces are removed and agreed test parameters are used for statistical process control. Inspection of mass-produced components is automated whenever economically feasible.

Post-processing and conservation

In many cases Balzers carries out post-processing, for example when the coated components must be demagnetised or conserved.

Mechanical finishing of coatings is becoming more and more important. Even though coating increases the surface roughness only slightly, the removal of tiny metal droplets or growth errors can further increase the tribological performance of coated parts.



Surface of a PVD arc coating with droplets, without finishing

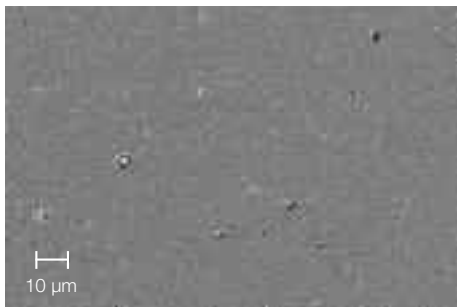

Surface of a PVD arc coating after finishing

Packaging and shipping

Coated components are usually re-shipped in the same containers in which they were received. Savings can be realised if the components arrive already packed in suitable cleaning baskets.

Quality management

Quality management does not start when the goods are received. An understanding of what quality means and an active partnership with the customer impel Balzers to provide support throughout the course of a project. This effort includes customised solution proposals that range from the choice of coating to (for example) how a product can be optimally packaged and conserved for shipment in order to create the best conditions for the coating process.

“Zero defects”

The Balzers quality objective is “zero defects.” This level of quality is achieved with certified, process-based quality management. All Balzers coating centres world-wide have ISO 9001 certification. Furthermore, Balzers was the first coating company to receive a QS-9000 certificate for coating centres that have specialised in the coating of precision components. All production

facilities supplying the automotive industry are additionally certified under ISO/TS 16949. Currently the coating centres in Lagny-sur-Marne/FR, Milton Keynes/UK and Luxembourg/LU are accredited to NADCAP quality standard for the aerospace industry.

To Balzers, quality means meeting the customer’s requirements; this is the key to customer satisfaction. Control of the coating process, modern testing laboratory management, availability of test instruments, and the use of statistical process control (SPC) are therefore the day-to-day components of Balzers technical quality control, which is based on many years’ experience in high volume production.

Quality management is not something static but a process that is a way of life and an area of continuous improvement for Balzers.



Certified quality management

All Balzers coating centres throughout the world are certified under ISO 9001. Centres specialising in coating parts for the automotive industry are also certified to ISO/TS 16949.

Glossary

Abrasion

Abrasive wear

Removal of material from surfaces by hard or sharp-edged surfaces or particles and by contaminants in the medium between surfaces.

Adhesion

Adhesive wear

Formation of adhered material at the interface between two sliding solids, which when broken can result in transfer of material. The extent of this transfer is greater the more intimate the contact and the smaller the amount of foreign substances present between the surfaces.

Anti-wear coatings

See Hard coatings.

Arc evaporation

A vacuum coating process in which the coating material is evaporated by an electric arc.

BALINIT®

Trademark for hard coatings made and marketed by Balzers.

Batch

Products placed in coating equipment for processing in a single operation.

Brinelling

Permanent deformation of a material due to vibrating and oscillating loads (e.g., in ball bearings).

Carousel

A rotating fixture that holds components on special mounts.

Cavitation erosion

Damage to a solid surface in contact with a flowing liquid due to pressure waves generated by collapsing (imploding) vapour bubbles.

Cavities

Tight or narrow depressions (holes, grooves) in a surface, making the material difficult to coat by PVD or PACVD.

Chemical plating

(chemical nickel)

Electroless deposition of metal coatings from salt solutions with a reducing agent, coatings contain phosphorous or boron.

Coefficient of friction

The coefficient of friction μ is the ratio of frictional force to normal force between two bodies in relative motion ($\mu = FR/FN$). The coefficient of dry friction is the value measured in a system with no lubrication.

Cold welding

Solid bonding between two sliding surfaces due to metal-to-metal contact under high pressure or with insufficient separation by lubrication (see also Adhesion).

Corrosion

Damage to a metal, beginning at the surface, due to chemical or electrochemical reactions with partners in the ambient medium.

CrN coating

(chromium nitride)

A hard coating applied by PVD.

CVD

(chemical vapour deposition)

A thermally activated chemical process for depositing a coating from the gas phase under vacuum.

Degassing

Thermal treatment in a vacuum system to allow through and blind holes and surfaces to outgas (see also outgassing).

DLC coating

(diamond-like carbon)

A hard coating applied by PACVD.

Eggshell effect

A failure of hard coatings under heavy load due to inadequate support by the substrate. The initial damage has a cracked eggshell-like appearance.

Electroplating

(electroplated chrome, nickel)

Electrochemical deposition of metal coatings on electrically conductive surfaces from salt solutions.

Erosion

Damage to a solid surface in contact with a flowing liquid, caused by mechanical action of hard particles in the liquid.

Fretting

A form of wear occurring when two frictional partners move tangentially to each other in small oscillating motions. See also Adhesion.

Fretting corrosion

See Tribo-oxidation.

Friction

The mechanical resistance observed when bodies in contact move relative to one another. Friction manifests itself as a force or as energy.

Friction

(type or mode)

Friction is described as sliding, rolling or combined sliding and rolling, according to the way in which the frictional partners move.

Frictional state

Friction is described as dry, boundary, mixed, fluid or gas friction, according to the state of the contact between the frictional partners.

Galling

A more severe form of adhesive wear associated with gross surface damage, chipping and transfer or displacement of large material fragments.

Hard coatings

Coatings of very hard materials (commonly metal carbides or nitrides, sometimes silicides, or diamond-like carbon) applied to surfaces in order to impart greater resistance to wear and lower the coefficient of friction.

Heat-treatment

The temperature of the final heat treatment (tempering, precipitation hardening, annealing) must not be exceeded during coating because structural changes in the part may occur otherwise.

Hertzian pressure

Effective pressure at the surface of contact between two arbitrarily curved solids.

Ion etching

Removal of material from a surface by ion bombardment.

Ion plating

A vacuum coating process in which the coating material is evaporated by an electron beam.

Ionisation**Degree of ionisation**

Production of electrically charged particles (ions and electrons) in a gas by various kinds of excitation (e.g., temperature, electric arc, high-frequency waves). The strength or extent of ionisation is measured by the degree of ionisation.

Microblasting

Bombardment of a surface with very fine abrasive (e.g., corundum with a grain size of 10-20 μm) in order to remove contaminants or impart structure or texture.

Micropitting

(grey staining)

A form of surface degradation found in gears, thought to be related to surface fatigue.

Monolayer coating

A hard coating applied in the form of a single homogeneous layer.

Multilayer coating

A "stack" of hard coating layers varying in their properties.

Nitriding

(including plasma nitriding)

A thermochemical treatment for upgrading (hardening, passivating) surface regions of ferrous materials by allowing nitrogen from solutions or gases to diffuse into the material. Called "plasma nitriding" if performed with the aid of a plasma.

Outgassing

Thermal evaporation of organic residues and trapped gases.

PACVD

(plasma-assisted chemical vapour deposition)

A vacuum process for depositing a coating from the gas phase by a chemical reaction aided by a plasma.

Passivating layer

A layer that renders a surface less susceptible to chemical attack.

Phosphating

A chemical treatment of ferrous materials with a dilute phosphoric acid, by which the surface is converted to an integral, mildly protective layer of insoluble phosphate.

Pitting

See Surface fatigue.

Plasma

A gas-like state often called the "fourth state of matter", comprising electrically charged species (ions, electrons, excited and neutral particles).

Plasma polymer

A coating made up of a polymer deposited from the gas phase by plasma action.

Plasma-assisted coating processes

See Vacuum coating processes.

PVD

(physical vapour deposition)

A vacuum coating process in which the coating material is physically deposited from the vapour phase. Processes include ion plating, thermal/arc evaporation and sputtering.

Residual stress

Elastic stresses in a coating, existing when no external forces and moments are applied and mechanical equilibrium holds. Residual stresses affect such properties as coating adhesion.

Scuffing

Localised surface damage in between sliding surfaces due to adhesive wear, associated with cold welding and the breakdown of lubrication at high loads and/or sliding speeds.

Seizing

The most severe form of adhesive wear: cold welding due to high friction between the mating parts.

Sputtering**Enhanced sputtering**

A vacuum coating process in which the coating material is atomised by ion bombardment.

Stick-slip

The discontinuous or jerky motion of two frictional partners. Static and sliding friction alternate.

Substrate

The component or the parent material to be coated.

Surface engineering

Design and treatment of surfaces to achieve optimum wear properties.

Surface fatigue

Damage to a surface due to dynamic loading. Surface fatigue results in the formation of cracks and the removal of material in particle form (pitting, micro-pitting).

TiN coating

(titanium nitride)

A hard coating applied by PVD.

Tribology

The science and technology of interacting surfaces in motion relative to one another. Tribology deals with processes such as wear, friction and lubrication.

Tribo-oxidation

The oxidation of surfaces caused by frictional contacts in the tribosystem (e.g., fretting corrosion).

Tribosystem**Tribological system**

The tribosystem consists of the structure and the input and output conditions. The structure includes the material elements (frictional partners, lubricant, contaminants), their properties and interactions. As the input conditions (forces, motion, temperature) act upon the structure, they are transformed into useful quantities (work performed) and loss quantities (friction, wear).

Ultrasonic cleaning

The cleaning of solid surfaces in liquids (aqueous detergent solutions or organic solvents) with the aid of ultrasound.

Vacuum coating processes

Processes for the application of homogeneous coatings to material surfaces using chemical and physical processes carried out under high vacuum. Vacuum coating processes include PVD, CVD and PACVD.

WC/C coating

(tungsten carbide/carbon)

A hard coating applied by PVD.

Wear

Progressive loss of material from the surface of a solid body due to tribological action.

Wear mechanisms

The physical and chemical processes that cause the damage or wear. Wear mechanisms include adhesion, abrasion, surface fatigue and tribo-oxidation.

Wear resistance**Coefficient of wear**

The ability of a solid body to prevent progressive loss of material from its surface due to mechanical loading. The coefficient of wear is determined by system-specific measurements.

Wear-protection coatings

See Hard coatings.

